



SERVICE MANUAL

DUAL BAND FM TRANSCEIVER

IC-3230H

IC-3230A

IC-3230E

INTRODUCTION

This service manual describes the latest information for the **IC-3220H/A/E DUAL BAND FM TRANSCEIVER** at the time of publication.

MODEL	VERSION NO.	VERSION	SYMBOL
IC-3230H	#22	Europe	EUR-2
	#23	Italy	EUR-3
	#25	U.S.A.	USA-1
	#27	Australia	AUS-1
	#28	Asia	SEA-1
IC-3230A	#25	U.S.A.	USA-1
	#27	Australia	AUS-1
	#28	Asia	SEA-1
IC-3230E	#22	Europe	EUR-2
	#23	Italy	EUR-3

DANGER

NEVER connect the transceiver to an AC outlet or to a DC power supply that uses more than 16 V. This will ruin the transceiver.

DO NOT expose the transceiver to rain, snow or any liquids.

DO NOT reverse the polarities of the DC power supply when connecting the transceiver.

DO NOT apply an RF signal of more than 20 dBm (100 mW) to the antenna connector. This could damage the transceiver's front end.

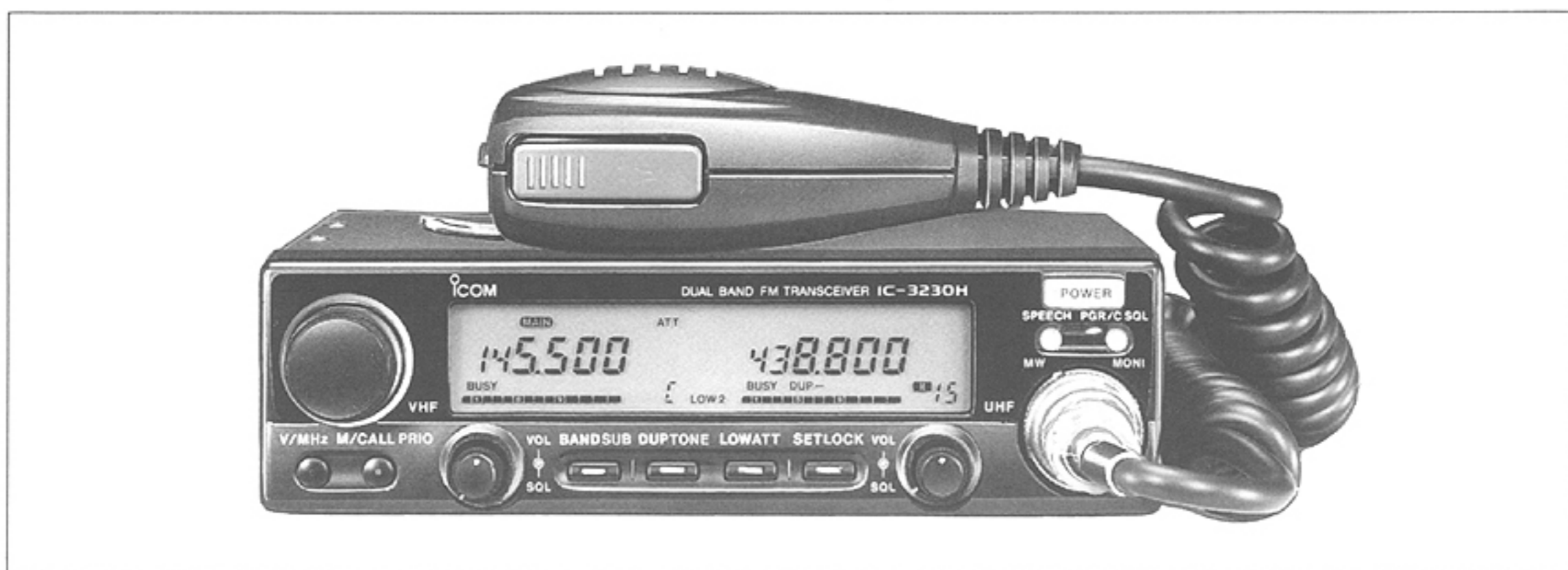

This picture shows the IC-3230H version.

ORDERING PARTS

Be sure to include the following four points when ordering replacement parts:

1. 10-digit order numbers
2. Component part number and name
3. Equipment model name and unit name
4. Quantity required

<SAMPLE ORDER>

1130004200	IC	TC4S66F	IC-3230A/E/H	MAIN UNIT	1 pieces
8810000010	Screw	FH M2 x 4	IC-3230A/E/H	Top cover	4 pieces

Addresses are provided on the inside back cover for your convenience.

REPAIR NOTES

1. Make sure a problem is internal before disassembling the transceiver.
2. **DO NOT** open the transceiver until the transceiver is disconnected from its power source.
3. **DO NOT** force any of the variable components. Turn them slowly and smoothly.
4. **DO NOT** short any circuits or electronic parts. An insulated tuning tool **MUST** be used for all adjustments.
5. **DO NOT** keep power ON for a long time when the transceiver is defective.
6. **DO NOT** transmit power into a signal generator or a sweep generator.
7. **ALWAYS** connect a 40 dB ~ 50 dB attenuator between the transceiver and a deviation meter or spectrum analyser when using such test equipment.
8. **READ** the instructions of test equipment thoroughly before connecting equipment to the transceiver.

TABLE OF CONTENTS

SECTION	1	SPECIFICATIONS	1 - 1
SECTION	2	INSIDE VIEWS	2 - 1
SECTION	3	CIRCUIT DESCRIPTION	3 - 1 ~ 6
	3 - 1	RECEIVER CIRCUITS	3 - 1
	3 - 2	TRANSMITTER CIRCUITS	3 - 3
	3 - 3	PLL CIRCUITS	3 - 4
	3 - 4	OTHER CIRCUITS	3 - 5
	3 - 5	CPU PORT ALLOCATIONS	3 - 6
SECTION	4	MECHANICAL PARTS AND DISASSEMBLY	4 - 1 ~ 4
SECTION	5	PARTS LIST	5 - 1 ~ 11
SECTION	6	ADJUSTMENT PROCEDURES	6 - 1 ~ 7
	6 - 1	PREPARATION BEFORE SERVICING	6 - 1
	6 - 2	PLL ADJUSTMENT	6 - 2
	6 - 3	RECEIVER ADJUSTMENT	6 - 4
	6 - 4	TRANSMITTER ADJUSTMENT	6 - 6
SECTION	7	BOARD LAYOUTS	7 - 1 ~ 10
	7 - 1	LOGIC UNIT, VR-A AND VR-B UNITS	7 - 1
	7 - 2	DISPLAY UNIT	7 - 3
	7 - 3	MAIN-A UNIT AND VCO-A UNIT	7 - 4
	7 - 4	MAIN-B UNIT, VCO-B AND B-BAND UNITS	7 - 7
	7 - 5	TONE UNIT (U.S.A. version only)	7 - 10
SECTION	8	BLOCK DIAGRAM	8 - 1
SECTION	9	VOLTAGE DIAGRAM	9 - 1

To upgrade quality, all electrical or mechanical parts and internal circuits are subject to change without notice or obligation.

SECTION 1 SPECIFICATIONS

GENERAL

- Frequency coverage

VERSION	VHF	UHF
U.S.A.	144.000 ~ 148.000 MHz (Tx) 136.000 ~ 174.000 MHz* (Rx)	440.000 ~ 450.000 MHz
Europe	144.000 ~ 146.000 MHz	430.000 ~ 440.000 MHz
Australia	144.000 ~ 148.000 MHz	430.000 ~ 440.000 MHz
Asia Italy	144.000 ~ 148.000 MHz* (Tx) 136.000 ~ 174.000 MHz* (Rx)	430.000 ~ 440.000 MHz

* Specifications guaranteed for 144.000 ~ 148.000 MHz.

- Tuning step increments

: 5, 10, 12.5, 15, 20, 25 kHz, 1 MHz or 10 MHz*

* 10 MHz steps: On the 144 MHz band only for the U.S.A., Italy and Asia versions.

- Number of memory channels

	VHF	UHF
Memory channels	15	15
Call channels	1	1
Scan edge channels	2	2

- Mode

: FM (F3)

- Antenna impedance

: 50 Ω nominal

- Power supply requirement

: 13.8 V DC \pm 15 % (negative ground)

- Usable temperature range

: $-10^{\circ}\text{C} \sim +60^{\circ}\text{C}$ ($-14^{\circ}\text{F} \sim +140^{\circ}\text{F}$)

- Dimensions

: 140 (W) x 40 (H) x 165 (D) mm

5.5 (W) x 1.6 (H) x 6.5 (D) in

(Projections not included)

- Weight

: 1.25 kg (2.8 lb)

TRANSMITTER

- Modulation system

: Variable reactance frequency modulation

- Max. frequency deviation

: \pm 5 kHz

- Spurious emissions

: Less than -60 dB

- Microphone impedance

: 600 Ω

- Output power and current drain
(at 13.8 V DC)

		IC-3230H		IC-3230A/E	
		POWER	CURRENT	POWER	CURRENT
VHF	High	45 W	10.5 A	25 W	7.0 A
	Low-2	10 W	5.5 A	10 W	4.5 A
	Low-1	5 W	4.0 A	1 W	2.5 A
UHF	High	35 W	10.5 A	25 W	8.0 A
	Low-2	10 W	6.0 A	10 W	5.0 A
	Low-1	5 W	4.5 A	1 W	3.0 A

RECEIVER

- Receive system

: Double-conversion superheterodyne

- Intermediate frequencies

: 1st 17.2 MHz (VHF)
30.85 MHz (UHF)

2nd 455 kHz

- Sensitivity

: Less than 0.16 μV for 12 dB SINAD

- Squelch threshold sensitivity

: Less than 0.13 μV

- Selectivity

: More than 15 kHz/ -6 dB

: Less than 30 kHz/ -60 dB

- Spurious rejection ratio

: More than 60 dB

- Audio output power

: More than 2.4 W at 10 % distortion with an 8 Ω load

- Current drain

: Max. audio output 1.8 A

Squelched 1.2 A

- Audio output impedance

: 4 ~ 8 Ω

All stated specifications are subject to change without notice or obligation.

SECTION 2 INSIDE VIEWS

• MAIN-A UNIT

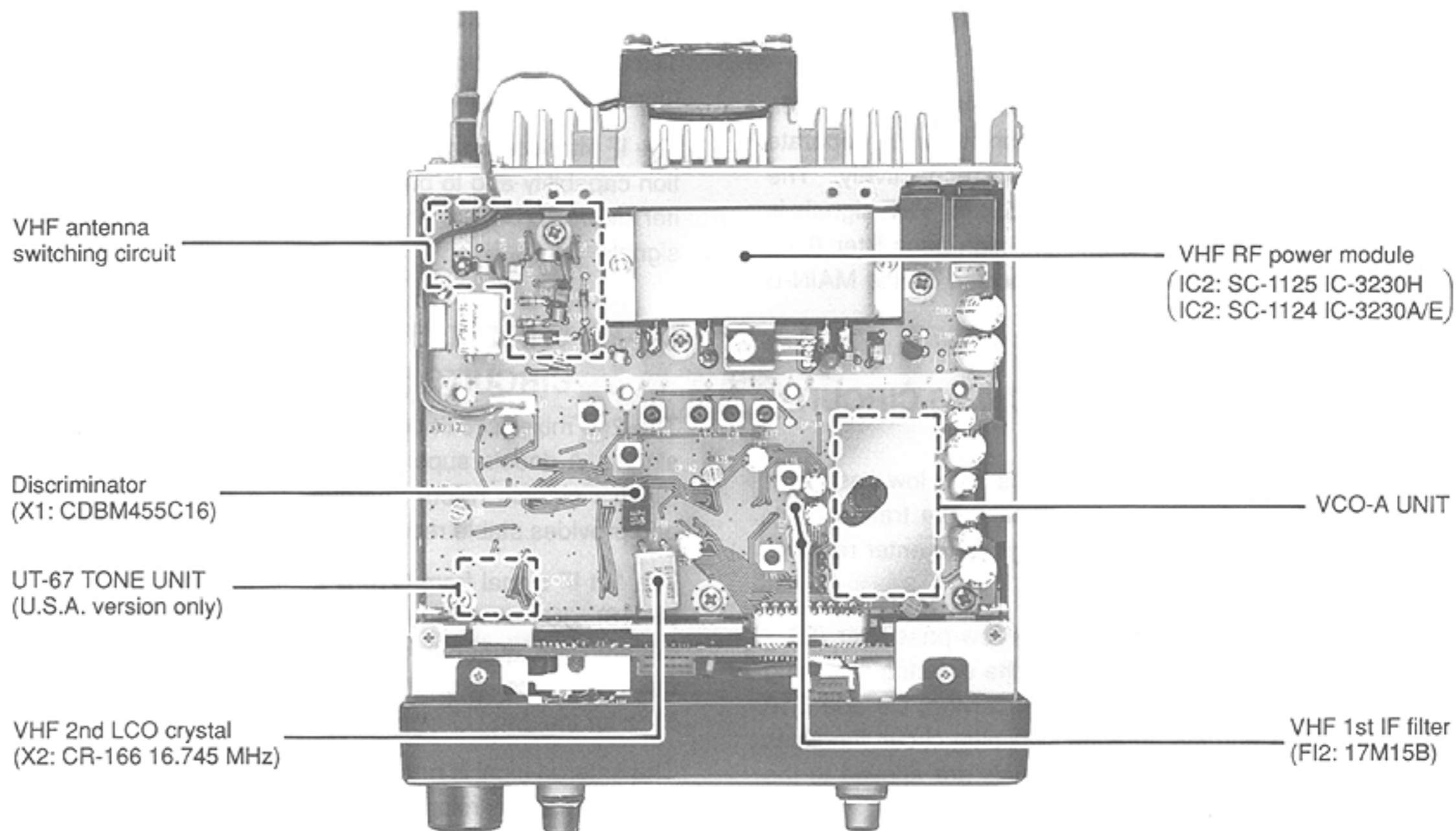

• MAIN-B UNIT

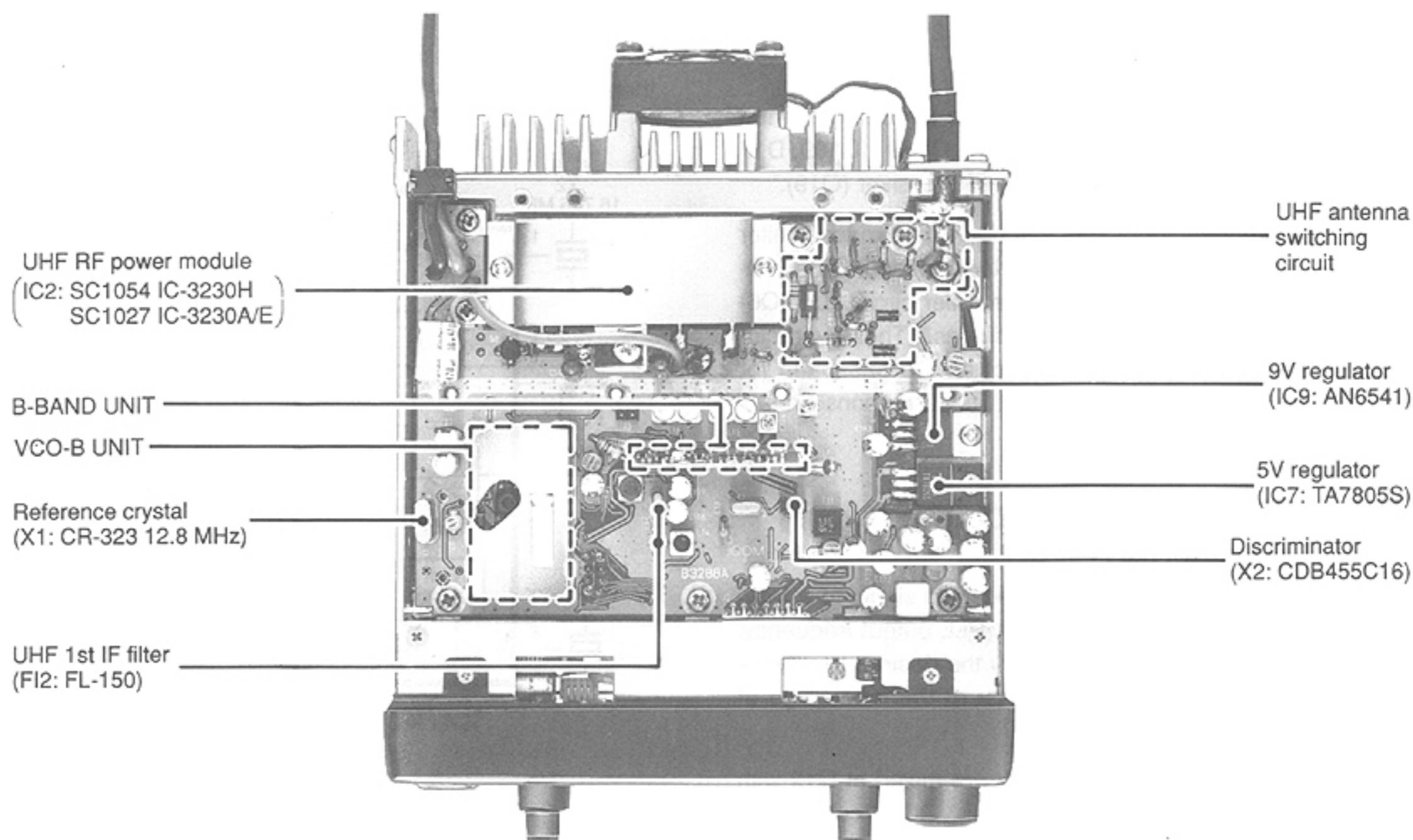

SECTION 3 CIRCUIT DESCRIPTION

3-1 RECEIVER CIRCUITS

3-1-1 DUPLEXER CIRCUIT (MAIN-A AND MAIN-B UNITS)

The transceiver has a low-pass filter and a high-pass filter, on the first stage from the antenna connector, to separate the signals into VHF and UHF signals respectively. The low-pass filter (L9 ~ L11, C56, C58, C59) for VHF signals is located on the MAIN-A unit, and the high-pass filter (L11, L12, C78 ~ C80) for UHF signals is located on the MAIN-B unit.

3-1-2 VHF ANTENNA SWITCHING CIRCUIT (MAIN-A UNIT)

The antenna switching circuit functions as a low-pass filter while receiving and a resonator circuit while transmitting. The circuit does not allow transmit signals to enter receiver circuits.

The VHF signals, passed through the low-pass filter (L9 ~ L11, C56, C58, C59), are applied to the antenna switching circuit (L12, L13, D9, D10). While receiving, D9 and D10 are turned OFF, and the antenna switching circuit functions as a low-pass filter. The filtered signals are applied to the VHF RF circuit.

3-1-3 VHF RF CIRCUIT

The RF circuit amplifies signals within the range of the frequency coverage and filters out-of-band signals. The signals from the VHF antenna switching circuit pass through a tuned bandpass filter (L20, C119 ~ C121, D20) and are applied to the RF amplifier (Q21).

Amplified signals at Q21 are applied to a three-stage tuned bandpass filter (L17 ~ L19, C99 ~ C101, C103 ~ C109, D17 ~ D19) and are then applied to the VHF 1st mixer (Q19).

D17 ~ D20 are varactor diodes that track the bandpass filter and are controlled by the VHF PLL lock voltage. The voltage is current amplified by the DC amplifier circuit (Q5, Q6) and is then applied to the varactor diodes. These varactor diodes tune the center frequency of an RF passband for wide bandwidth receiving and good image response rejection.

3-1-4 VHF 1ST MIXER CIRCUIT (MAIN-A UNIT)

The 1st mixer circuit converts the received signal to a fixed frequency of the 1st IF signal with a PLL output frequency. By changing the PLL frequency, only the desired frequency will be passed through a crystal filter at the next stage of the 1st mixer.

The signals from the VHF RF circuit are mixed at Q19 with a 1st LO signal coming from the VHF VCO circuit to produce a 17.2 MHz 1st IF signal.

3-1-5 VHF 1st IF CIRCUIT (MAIN-A UNIT)

The 1st IF signal passes through the IF filter (FI2), and is then amplified by the IF amplifier (Q14).

The IF filter consists of a pair of crystal filters for wide selection capability and to pass only the desired signal. The limiter diode (D14) protects subsequent circuits from strong signals.

3-1-6 VHF 2ND IF AND DEMODULATOR CIRCUITS (MAIN-A UNIT)

The 2nd mixer circuit converts the 1st IF signal to a 2nd IF signal. A double superheterodyne system (which converts receive signals twice) improves the image rejection ratio and provides stable receiver gain.

The 1st IF signal from Q14 is applied to the FM IF IC (IC4, pin 16). IC4 contains the mixer, local oscillator circuit, limiter amplifier, quadrature detector circuit and active filter circuit. The local oscillator section and X2 generate 16.745 MHz for the 2nd LO signal.

The entered signal is mixed with a 2nd LO signal at the mixer section for conversion to a 455 kHz 2nd IF signal. The 2nd IF from the 2nd mixer (IC4, pin 3) passes through a high quality ceramic filter (FI1) to suppress unwanted heterodyned frequency signals. It is then amplified at the limiter amplifier section (IC4, pin 5) and applied to the quadrature detector section (IC4, pins 7,8 and ceramic discriminator X1) to demodulate the 2nd IF signal into an AF signal.

The signal is output from IC4 (pin 9) as a "DETV" signal and then applied to the AF circuit.

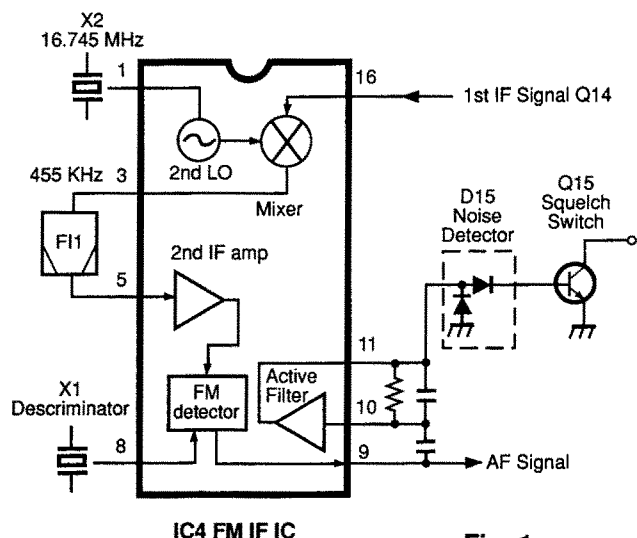

Fig. 1

3-1-7 VHF AF CIRCUIT (MAIN-A, VR-A AND LOGIC UNITS)

The AF circuit de-emphasizes the demodulated signal with -6 dB/octave and power amplifies the signal to drive a speaker. The AF circuit includes a mute circuit to mute the signal.

The "DETV" signal from IC4 (pin 9) is applied to the analog switch (IC5, pin 10) in the AF circuit. Switch control is performed by the CPU via the data expander IC (IC7).

The AF signal from IC5 (pin 8) is applied to the active filter (Q29, Q31). This filter has frequency characteristics of -6 dB/octave and suppresses the tone squelch operation.

The filtered signal passes through the [V VOL] control on the VR-A unit and is then applied to the AF power amplifier circuit (IC9, pin 2) via the V mute switch (Q34).

3-1-8 AF POWER AMPLIFIER CIRCUIT (MAIN-A UNIT)

The AF power amplifier circuit employs a 2-channel stereo IC (IC9) for separate output of VHF and UHF audio.

VHF and UHF audio signals are input at pins 2 and 5 of IC9 respectively. When no plug is connected to the [144 MHz SP] jack, the amplified VHF audio signal is combined with the UHF audio input signal via the attenuator (R157, R158). The combined signals are amplified at the UHF power amplifier (IC9, pin 5) and are then applied to the [430 (440) SP] jack or the internal speaker.

Q34 and Q35 are AF mute switches for VHF and UHF audio respectively. Q36 is an AF mute switch which affects both VHF and UHF signals. See Figure 2.

3-1-9 VHF SQUELCH CIRCUIT (MAIN-A and LOGIC UNITS)

A squelch circuit cuts out AF signals when no RF signal is received. By detecting noise components in the AF signals, the squelch circuit switches the AF mute switches.

Some noise components in the AF signal from IC4 (pin 9) are applied to the active filter section (IC4, pin 10). See Figure 1.

The active filter section amplifies noise components of frequencies 20 kHz and above, and outputs the resulting signals from pin 11. Output signals are rectified by D15 and trigger the squelch switch (Q15). The collector of Q15 outputs the squelch signal. This signal is applied to IC4 (pin 18) on the LOGIC unit through the "SQLSV" line.

3-1-10 UHF RF CIRCUIT (MAIN-B UNIT)

The UHF RF signals passed through the high-pass filter (L11, L12, C78 ~ C80) are then passed through the low-pass filter (L9, L10, C75 ~ C79) and antenna switching circuit (D16, D17, L22).

A control voltage for the antenna switching circuit uses T8 V which comes from D9.

The UHF RF signals are then amplified at the RF amplifiers (Q17, Q18) within the range of the UHF band signals using the helical band-pass filters (L18, L19).

3-1-11 UHF 1ST MIXER AND 1ST IF CIRCUITS (MAIN-B UNIT)

The signals from the UHF RF circuit are mixed at Q16 with a 1st LO signal coming from the UHF VCO circuit (Q1, D1) in the VCO-B unit to produce a 30.85 MHz 1st IF signal.

The 1st IF signal passes through the pair of crystal filters (F12) and is then amplified at Q13 and applied to the FM IF IC (IC4).

3-1-12 UHF 2ND IF AND DEMODULATOR CIRCUITS (MAIN-B UNIT)

A 2nd mixer, 2nd IF and demodulator circuits are incorporated in IC4 and operate in the same manner as the VHF 2nd IF and demodulator circuits.

Refer to Section 3-1-6 for details.

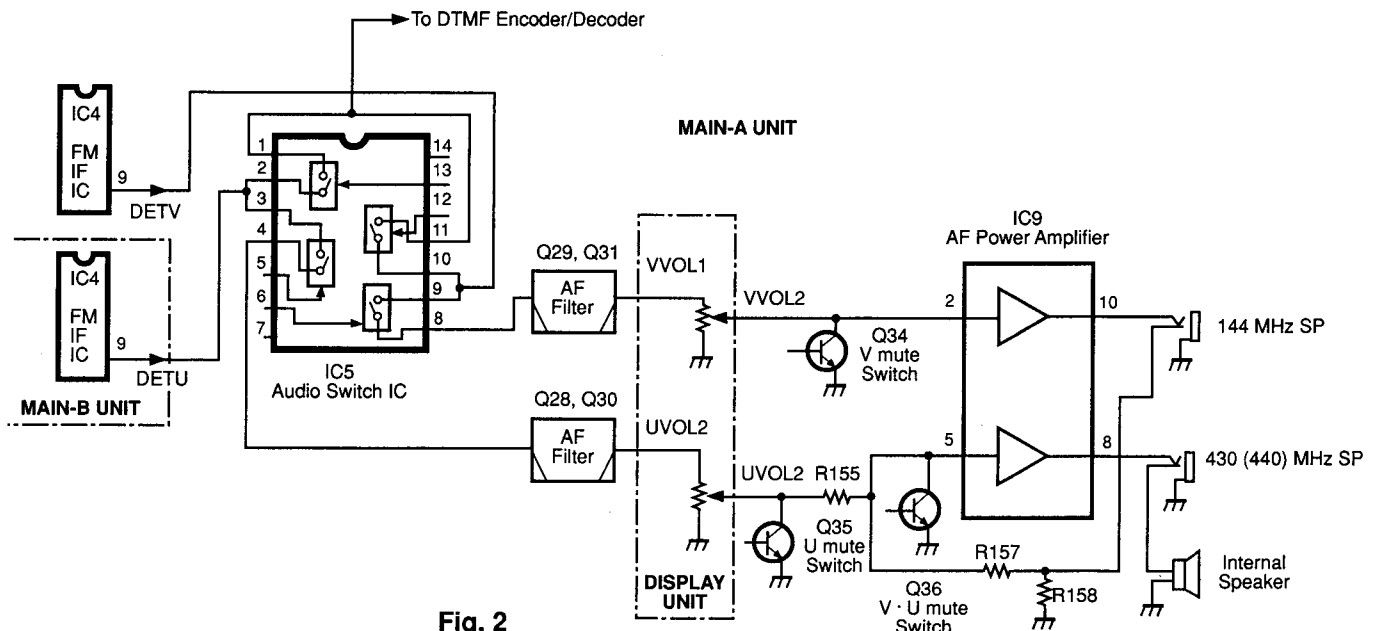

Fig. 2

3-1-13 UHF AF CIRCUIT (MAIN-B, MAIN-A AND VR-B UNITS)

The "DETU" signal from IC4 (pin 9) is applied to the analog switch (IC5) in the AF circuit on the MAIN-A unit.

The AF signal from IC5 (pin 4) is applied to the active filter (Q28, Q30). The filtered signal passes through the [U VOL] control and is then applied to the AF power amplifier circuit (described in Section 3-1-7) via the UHF audio mute circuit (Q35).

3-1-14 UHF SQUELCH CIRCUIT (MAIN-B UNIT)

Some noise components in the AF signal from IC4 (pin 9) are applied to an active filter section (IC4, pin 10). See Figure 1.

The active filter section amplifies noise components with frequencies of 20 kHz and above, and outputs the resulting signals from pin 11. Output signals trigger the squelch switch (Q14). The collector of Q14 outputs the squelch signal. The signal is applied to IC4 (Pin 19) on the LOGIC unit through the "SQLSU" signal line.

3-2 TRANSMITTER CIRCUITS

3-2-1 MICROPHONE AMPLIFIER CIRCUIT (LOGIC UNIT)

The microphone amplifier circuit amplifies audio signals with a +6 dB/octave pre-emphasis from the microphone to a level needed for the modulation circuit. The microphone amplifier circuit is used for both the VHF and UHF bands.

The AF signals from the microphone on the LOGIC unit are amplified at the microphone amplifier circuit (Q11) via the microphone mute switch (Q7). The output signals from IC3a (pin 1) pass through a low-pass filter (IC3b). The filtered signals are applied to the MAIN-B unit as a "MOD" signal. The "MOD" signal is then separately applied to the UHF modulation switch (IC1 in the MAIN-B unit) and to the VHF modulation mute switch (IC1 in the MAIN-A unit).

3-2-2 VHF MODULATION CIRCUIT (VCO-A UNIT)

The modulation circuit modulates the VCO oscillating signal (RF signal) using the microphone audio signals.

The audio signals from the VHF modulation switch (IC1) in the MAIN-A unit are applied to the VCO circuit (Q5). The audio signals change the capacitance between the gate and the source of the VCO oscillator (Q5). In this way, the oscillated signal is modulated with the audio signal.

The oscillated signal is buffer amplified at Q6 and is then applied to the buffer-amplifier (Q4 in the MAIN-A unit) via the "LOOA" line.

3-2-3 VHF DRIVE AMPLIFIER CIRCUIT (MAIN-A UNIT)

The VCO output is buffer-amplified at Q4 and Q7 is then

applied to a low-pass filter (L3, L4, C18 ~ C21). After passing through the transmit/receive switching circuit (D3) the VCO output is amplified at the drive amplifier (Q8) to obtain 200 mW (23 dBm).

3-2-4 VHF POWER AMPLIFIER CIRCUIT (MAIN-A UNIT)

IC2 is a power module which provides a stable 45 W of output power (for IC-3230H) or 25 W of output power (for IC-3230A/E).

The RF signal from the drive amplifier (Q8) is applied to IC2 (pin 4). The amplified signal is output from IC2 (pin 1) and is then applied to the antenna connector through the antenna switching circuit (D8) and low-pass filter (C56, C58, C59, L9 ~ L11).

3-2-5 VHF APC CIRCUIT (MAIN-A UNIT)

This circuit controls current in the power module's first stage and current in the drive amplifier to protect the power module from antenna mismatching and to obtain stable RF output power from $\pm 15\%$ of the power source voltage range.

When the antenna impedance is matched at 50 Ω , the voltage detected at the APC detector circuit (L7, D6, D7) is at its minimum. The detected voltage is applied to an APC amplifier (IC3b, pin 6).

When the antenna impedance is mismatched, the voltage of IC3b (pin 6) exceeds the reference voltage of IC3b (pin 5). The output level from IC3b (pin 7) decreases. Q12 amplifies the current from the APC amplifier (IC3b) to control Q11. Q11 changes the supply voltage to Q8 and IC2.

This decreases the output power from the drive amplifier (Q8) and power amplifier (IC2) until the input voltage of IC3b (pin 6) reaches the same level as pin 5 of IC3b.

3-2-6 VHF OUTPUT POWER CONTROL CIRCUIT (MAIN-A UNIT)

The output power control circuit (Q9, Q10, R29 ~ R31, R34, R36) selects one of three output power levels (HIGH, LOW-2 or LOW-1) by selecting the APC reference voltage.

When "HIGH" output power is selected, Q9 and Q10 are turned OFF. The APC reference voltage is determined by R29 ~ R31 and is adjusted with R30. When "LOW-1" or "LOW-2" is selected, Q9 or Q10 selects the APC reference voltage respectively.

3-2-7 VHF ANTENNA SWITCHING CIRCUIT (MAIN-A UNIT)

When transmitting, D8, D9 and D10 are turned ON. The RF output power signal from IC2 is not permitted to enter the receiver circuit. The signal passes through a low-pass filter (C56, C58, C59, L9 ~ L11) and is then output from an antenna connector. The low-pass filter suppresses high harmonic components.

3-2-8 UHF MODULATION CIRCUIT (VCO-B UNIT)

The audio signals from the microphone amplifier circuit (described in Section 3-2-1) pass through the UHF modulation switch (IC1) in the MAIN-B unit and are then applied to the VCO circuit (Q1). Variable capacitance between the gate and source of Q1 is used for modulation.

The oscillated signal at the VCO (Q1) is buffer amplified by Q2 and Q7 in the VCO-B unit and Q6 in the MAIN-B unit and is then applied to the pre-drive amplifier (Q7).

3-2-9 UHF AMPLIFIER CIRCUIT (MAIN-B UNIT)

The RF signal from the buffer amplifier (Q6) passes through the transmit/receive switching diodes (D4, D5), and is amplified at the pre-drive amplifier (Q7), drive amplifier (Q8) and the power module (IC2) and is then applied to the antenna connector.

3-2-10 UHF APC CIRCUIT (MAIN-B UNIT)

When the antenna impedance is matched at 50 Ω , the voltage detected at the APC detector circuit (D7, D8, L7) is at its minimum. The detected voltage is applied to an APC amplifier (IC3b, pin 6).

When the antenna impedance is mismatched, the voltage of IC3b (pin 6) exceeds the reference voltage of IC3b (pin 5). The output level from IC3b (pin 7) decreases. Q12 amplifies the current from the APC amplifier (IC3b) which controls Q11. Q11 changes the supply voltage to Q8 and IC2.

This decreases the output power from the drive amplifier (Q8) and power amplifier (IC2) until the input voltage of IC3b (pin 6) reaches the same level as pin 5 of IC3b.

3-2-11 VHF OUTPUT POWER CONTROL CIRCUIT (MAIN-B UNIT)

The output power control circuit (Q9, Q10, R35 ~ R38) selects 1 of 3 output power levels (HIGH, LOW-2, LOW-1) by selecting the APC reference voltage.

When "HIGH" output power is selected, Q9 and Q10 are turned OFF. The APC reference voltage is determined by R35 ~ R37 and adjusted with R36.

When "LOW-1" or "LOW-2" output power is selected, Q9 or Q10 selects the APC reference voltage respectively.

3-3 PLL CIRCUITS

3-3-1 GENERAL

A PLL circuit steadily oscillates the transmit frequency and the receiver 1st LO frequency. An oscillated signal at a VCO is divided at a programmable divider and is then compared to the phase of the frequency with a reference oscillator at a phase detector.

The detected signal is converted to lock voltage's by a loop filter and is fed back to the VCO circuit. Thereby, a steady and variable oscillation can be obtained. See Figure 3.

3-3-2 VHF VCO CIRCUIT (VCO-A UNIT)

The VHF VCO circuit forms a Hartley oscillator circuit (Q5). Varactor diodes (D1, D2) provide frequency control. The buffer amplifier (Q6) is unaffected by VCO oscillation.

The oscillated signal is buffer amplified by Q6 and is then applied to the PLL IC (IC2, pin 5).

3-3-3 VHF PROGRAMMABLE DIVIDER AND PHASE DETECTOR CIRCUITS (VCO-A UNIT)

IC2 is a one-chip PLL IC that contains a programmable divider and a phase detector.

The signal enters the PLL IC (IC, pin 5) and is divided at the programmable divider section and is then applied to the phase detector section.

The phase detector compares the input signal and a reference frequency and outputs the off-phase signal (pulse-type signal) from pin 12.

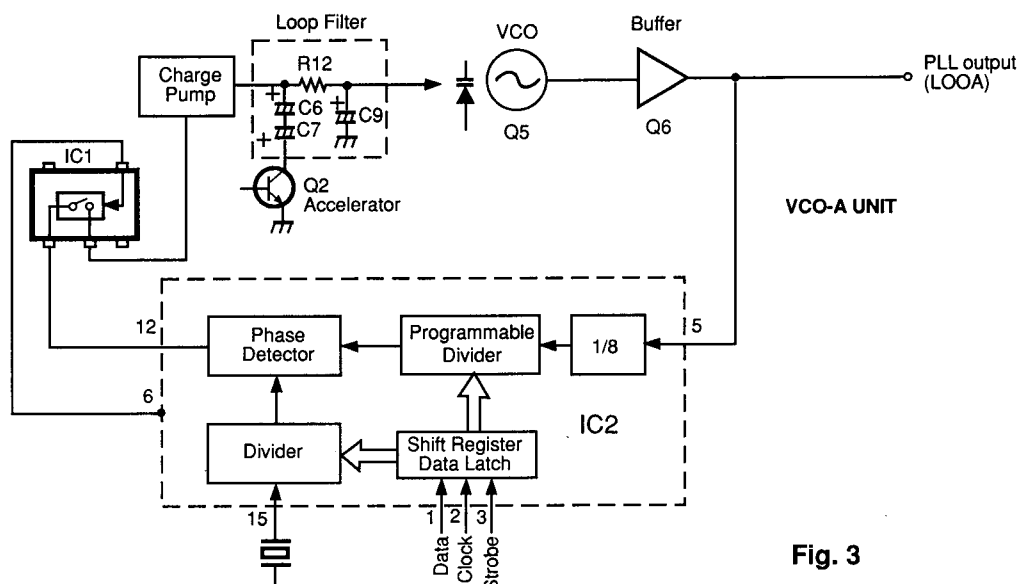

Fig. 3

3-3-4 REFERENCE OSCILLATOR CIRCUIT (MAIN-B UNIT)

A 12.8 MHz reference frequency is generated by the oscillator (Q3, X1). The frequency is adjusted by C6. The reference frequency is buffer amplified at Q4 and is then applied to both VHF and UHF PLL circuits.

3-3-5 VHF LOOP FILTER AND ACCELERATE CIRCUITS (VCO-A UNIT)

The phase detected signal passes through the analog switch (IC1) and is amplified by the charge pump (Q5, Q6).

IC2, pin 6 outputs "LOW" when the PLL is unlocked, such as the instant during transmit/receive switching. At this time, IC1 cuts the phase detected signal and sets the fast time constant to the loop filter (R12, C9) using C6 and C7.

The amplified signal from the charge pump is converted to DC voltage by the loop filter (R12, C9) and is applied to varactor diodes (D1, D2) in the VCO circuit to control and stabilize the oscillated frequency.

3-3-6 VHF UNLOCK SENSOR CIRCUIT (VCO-A AND LOGIC UNITS)

When the PLL circuit is unlocked, IC1 (pin 13) becomes "HIGH." The "HIGH" signal is applied to the CPU (IC4, pin 20) as an unlock signal on the LOGIC unit.

3-3-7 UHF PLL CIRCUITS (VCO-B UNIT)

The VCO oscillated signal is buffer amplified at Q2 and then applied to the PLL IC (IC2, pin 5).

The entered signal is divided at the programmable divider section and is then applied to the phase detector section inside IC2. A reference frequency is also applied to IC2, and the phase detector outputs the phase difference between the divided signal and the reference frequency via pin 12.

This off-phase signal is amplified at the charge pump (Q5, Q6) and is then converted to DC voltage by the loop filter (R22, C18).

The converted voltage is applied to varactor diodes (D1, D2) of the VCO circuit to control and stabilize the oscillated frequency.

3-4 OTHER CIRCUITS

3-4-1 S-METER CIRCUITS (LOGIC UNIT)

S-meter signals output from FM ICs (IC4, pin 13) are applied to the LOGIC unit via the "SRFV" line and "SRFU" line for the VHF and UHF bands respectively.

The comparators (IC5b for VHF and IC5a for UHF) output "HIGH." While the CPU (IC4, pin 12 or 13) receives "HIGH," the CPU increases the \ominus input of these comparators, via pins 4 ~ 7. When the \ominus input becomes higher than the \oplus input, the comparator outputs "LOW" and the output level of display pins 4 ~ 7 is output on the display.

3-4-2 CPU POWER SUPPLY CIRCUIT (LOGIC UNIT)

When the power switch is turned OFF, voltage is applied to the CPU (IC4, pin 26) via D1 from the lithium backup battery, installed on the LOGIC unit, to provide backup power for the memory contents.

3-4-3 CPU RESET CIRCUIT (LOGIC UNIT)

The reset IC (IC2) sets the CPU to the operating mode when turning power ON and sets it to the backup mode when turning power OFF.

When turning power ON, voltages in the "+5 V" line increase. When the voltages exceed the IC2 reference voltage, IC2 outputs "HIGH." The signal switches Q5 via Q6 for a moment in order to set the CPU to the operating mode.

When turning power OFF, IC2 applies "LOW" to the "BACKUP" port of the CPU before the voltage disappears from the +5 V line.

3-4-4 REGULATOR CIRCUIT (MAIN-B UNIT)

IC9 is a 3-terminal voltage regulator IC chip. +13.8 V is applied to the input terminal. The output terminal outputs a regulated +9 V (+8 V line) to each unit.

Q26, Q27 and D25 produce a regulated 8 V (+8 V line) for the MAIN-A unit. This regulator is composed of a complementary connection, to ensure high current amplification, and supplies stable output voltage continuously with good temperature characteristics.

IC7 is a 3-terminal voltage regulator IC chip. +13.8 V is applied to the input terminal. The output terminal outputs a regulated +5.5 V (5 V line) using D24.

D1 produces a regulated 24 V for the UHF loop filter circuit. This voltage is converted from 30 V DC which is produced by the DC-DC converter (IC8, Q28).

3-5 CPU PORT ALLOCATIONS

• IC4 CPU (LOGIC UNIT)

PIN	Port	Description
1	LCK	Outputs a serial clock signal for the LCD driver.
2 ~ 4	INISO ~ INIS2	Output strobe signals for the initial matrix.
5 ~ 7	KEYSO ~ KEYS1	Output strobe signals for the key matrix. These ports are also used for S-meter detection.
8 ~ 11	KEYI0 ~ KEYI3	Key return inputs ports.
12	VSRFI	Input port for a VHF S-meter detection signal.
13	USRFI	Input port for a UHF S-meter detection signal.
14	DIALUP	Input port for the dial up signal.
15	DIALDN	Input port for the dial down signal.
16	DIALCK	Input port for the dial clock signal.
17	BACKUP	The CPU enters the backup mode when this port receives "LOW."
18	SQLSV	Input port for the VHF squelch signal.
19	SQLSU	Input port for the UHF squelch signal.
20	UNLKV	Input port for the VHF PLL unlock signal.
21	UNLKU	Input port for the UHF PLL unlock signal.
22	CK	Outputs the serial clock synchronized with the serial data.
23	DATA	Outputs serial data.
24, 25	DIM0, DIM1	Output ports for display contrast.
29	R42	Output port for mic-remote function.
31	STBTV	Outputs a strobe signal for an optional VHF tone squelch.
32	STBTU	Outputs a strobe signal for an optional UHF tone squelch.
33	STBDT	Outputs a strobe signal for an optional DTMF decoder unit.
34	STBPLU	Outputs a strobe signal for the VHF PLL IC.
35	SBUSY	Outputs "HIGH" while an optional voice synthesizer unit is activated.
36	UNITS	Input port for connection of an optional voice synthesizer unit.
37	UNITD	Input port for connection of an optional DTMF decoder unit.
38	STD	Input port for detection of an optional DTMF decoder unit.
39 ~ 42	D0 ~ D3	4-bit data output ports for an optional DTMF decoder unit.
43	RESET	The CPU enters the operating mode when this port receives "HIGH."
48	TSQLV	Input port for the tone squelch open signal on the VHF band.

PIN	Port	Description
49	TSQLU	Input port for the tone squelch open signal on the UHF band.
50	UNITT	Input port for connection of an optional tone squelch unit.
51	STBPLV	Outputs a strobe signal for the VHF PLL IC.
52	STBUC	Outputs a strobe signal to the expander IC (IC5 in the MAIN-B unit).
53	STBAC	Outputs a strobe signal to the expander IC (IC7 in the MAIN-A unit).
54	STBVC	Outputs a strobe signal to the expander IC (IC6 in the MAIN-A unit).
55	STBSP	Outputs a strobe signal to an optional voice synthesizer unit.
56	MICCK	Input port for the clock signal for mic up/down.
57	MICU/D	Input port for the microphone up/down signal.
58	PTT	Input port for the PTT switch detection circuit.
59	BEEP	Outputs a beep signal.
61 ~ 64	LINH, LCE1, LCE2, DATA	Used for the LCD driver.

EXPANDER IC

• IC6 (MAIN-A UNIT)

PIN	Port	Description
13, 14	VLP1, VLP2	Output ports for the VHF output power selection.
12	VATT	Outputs "HIGH" when the VHF attenuator function is activated.
11	FANC	Outputs "HIGH" to activate the cooling fan.

• IC7 (MAIN-A UNIT)

PIN	Port	Description
4	VAMUTE	Outputs "HIGH" to mute the VHF audio signal.
5	UAMUTE	Outputs "HIGH" to mute the UHF audio signal.
6	VDMUTE	Outputs "HIGH" to mute the VHF audio detected signal.
7	UDMUTE	Outputs "HIGH" to mute the UHF audio detected signal.
11	VMAIN	Outputs "HIGH" when the VHF band is selected as the MAIN band.

• IC5 (MAIN-B UNIT)

PIN	Port	Description
11	UATT	Outputs "HIGH" when the UHF attenuator function is activated.
12, 13	ULP2, ULP1	Output ports for the UHF output power selection.

SECTION 4 MECHANICAL PARTS AND DISASSEMBLY

4-1 CHASSIS AND MAIN-A UNITS

LABEL NO.	ORDER NO.	DESCRIPTION	QTY.
①	8610007720	Knob N182 [VOL]	2
②	8610007740	Knob N181 [SQL]	2
③	8610006500	Knob N154	1
④	8210007220	1129 Front Panel (A) IC-3230A (incl. window panel)	1
	8210007230	1129 Front Panel (B) IC-3230E (incl. window panel)	1
	8210007240	1129 Front Panel (C) IC-3230H (incl. window panel)	1
⑤	8810006460	Screw FH M2 x 3	4
⑥	8010012030	1129 LOGIC Shield	1
⑦	8810002100	Screw FH M2.6 x 4	4
⑧	8610006510	Button K152 [V/MHz], [M/CALL]	2
⑨	8930023370	1129 2-Switch sponge	2
⑩	8010012100	1129 Reflector	1
⑪	8610006520	Button K150 [BAND], [DUP], etc.	4
⑫	8930023380	1129 4-Switch sponge	1
⑬	8830000550	VR nuts (E)	2
⑭	8610007710	Button K187 [MW], [MONI]	2
⑮	8610007710	Button K186 [POWER]	1
⑯	7210001910	Variable resistor RV-199 10KB/10KA [SQL, VOL]	2
⑰	2250000050	Encorder EVQ-WQGF15 24B [TUNING CONTROL]	1
⑱	8810000010	Screw PH M2 x 4	4
⑲	2260000580	Switch SKHLAD035A [V/MHz], [BAND] etc.	8
⑳	2230000550	Switch SPPH23079A [POWER]	1
㉑	8930012430	543 MIC spacer	1
㉒	6510000290	Connector 8S-S-E [MICROPHONE]	1
㉓	8810003960	Setscrew (A) M2.6 x 5	4

LABEL NO.	ORDER NO.	DESCRIPTION	QTY.
㉔	8810003160	Setscrew (A) M3 x 6	5
㉕	8010010900	969 chassis	1
㉖	8810004240	Tapping screw PH B1 2.6 x 4 NI	2
㉗	8930020860	IC-holder	1
㉘	8510006411	833 VCO case-1	1
㉙	8930020680	V-module holder	1
㉚	8810003660	ICOM screw (A) 5	1
㉛	8810001910	Screw PH M3 x 6 BS NI	2
㉜	8810003160	Setscrew (A) M3 x 6	4
㉝	8810002100	Screw FH M2.6 x 4	2
㉞	8510007580	V-PA Shild (A)	1
㉟	8810003160	Setscrew (A) M3 x 6	2
㊱	8930023840	1131 Fan spacer	1
㊲	2710003350	Fan MP40B-12H	1
㊳	8930024950	1131 Fan cover spacer	4
㊴	8930021020	Fan cover FG-40A	1
㊵	8820000700	1129 Screw	4
㊶	8810004230	Bottom cover	1
㊷	8930020661	Speaker plate-1	1
㊸	2510000470	Speaker EAS-6P100SA	1
㊹	8810006230	Screw OH M2.6 x 4 ZK	4
㊺	8810004290	Top cover (incl ㊴, ㊵)	1
㊻	8810006230	Screw FH M2.6 x 4 ZK	12
㊼	8930023390	1129 LCD rubber	1
㊽	8930023220	1129 LCD holder	1
㊾	5030000750	LCD FTD-10788AAH	1
㊿	8930023700	970 FILTER	1
①	8930023180	LCD CONTACT SRCN-1129W	1

Screw abbreviations PH: Pan head FH: Flat head NI: Nickel ZK: Black

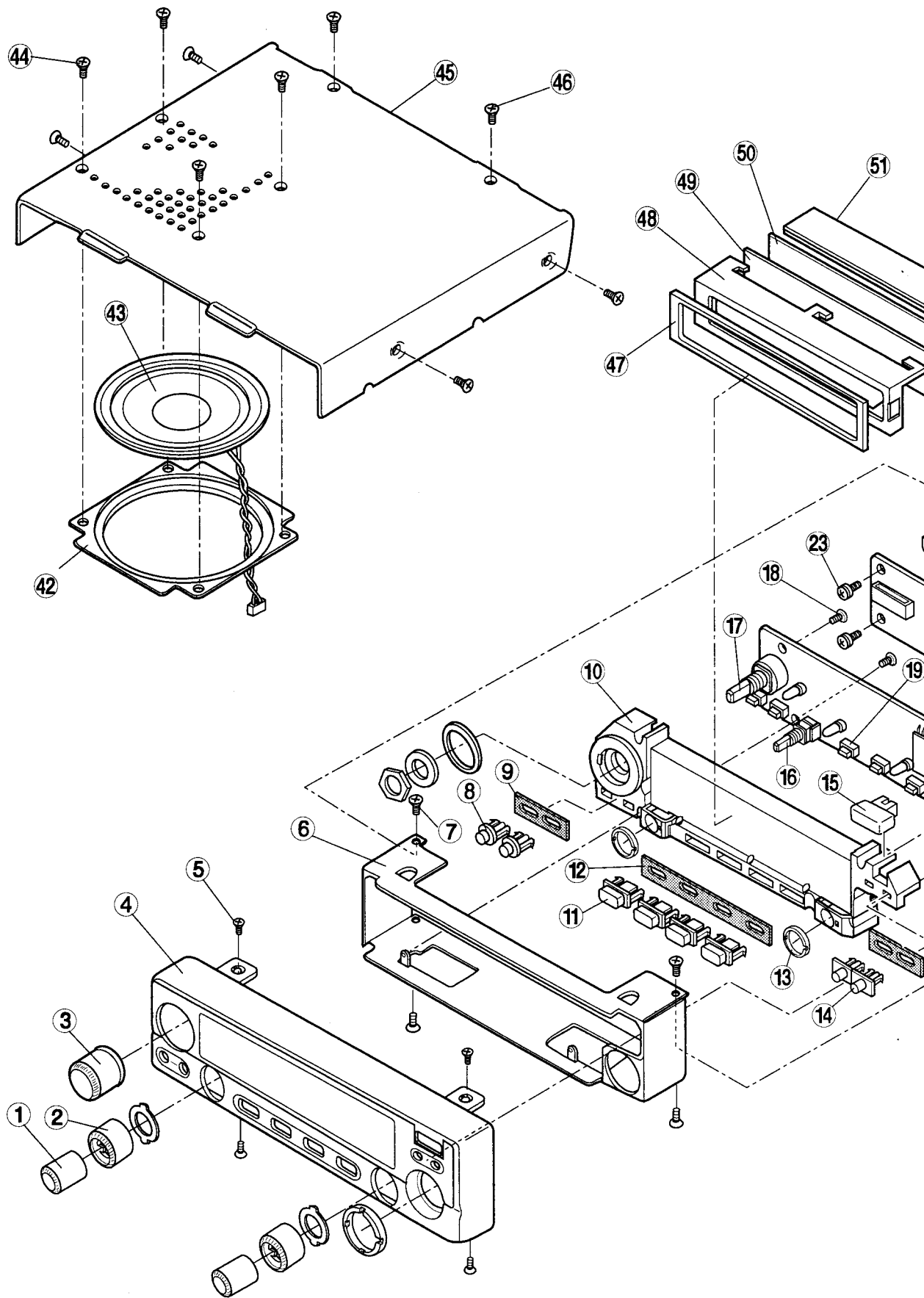

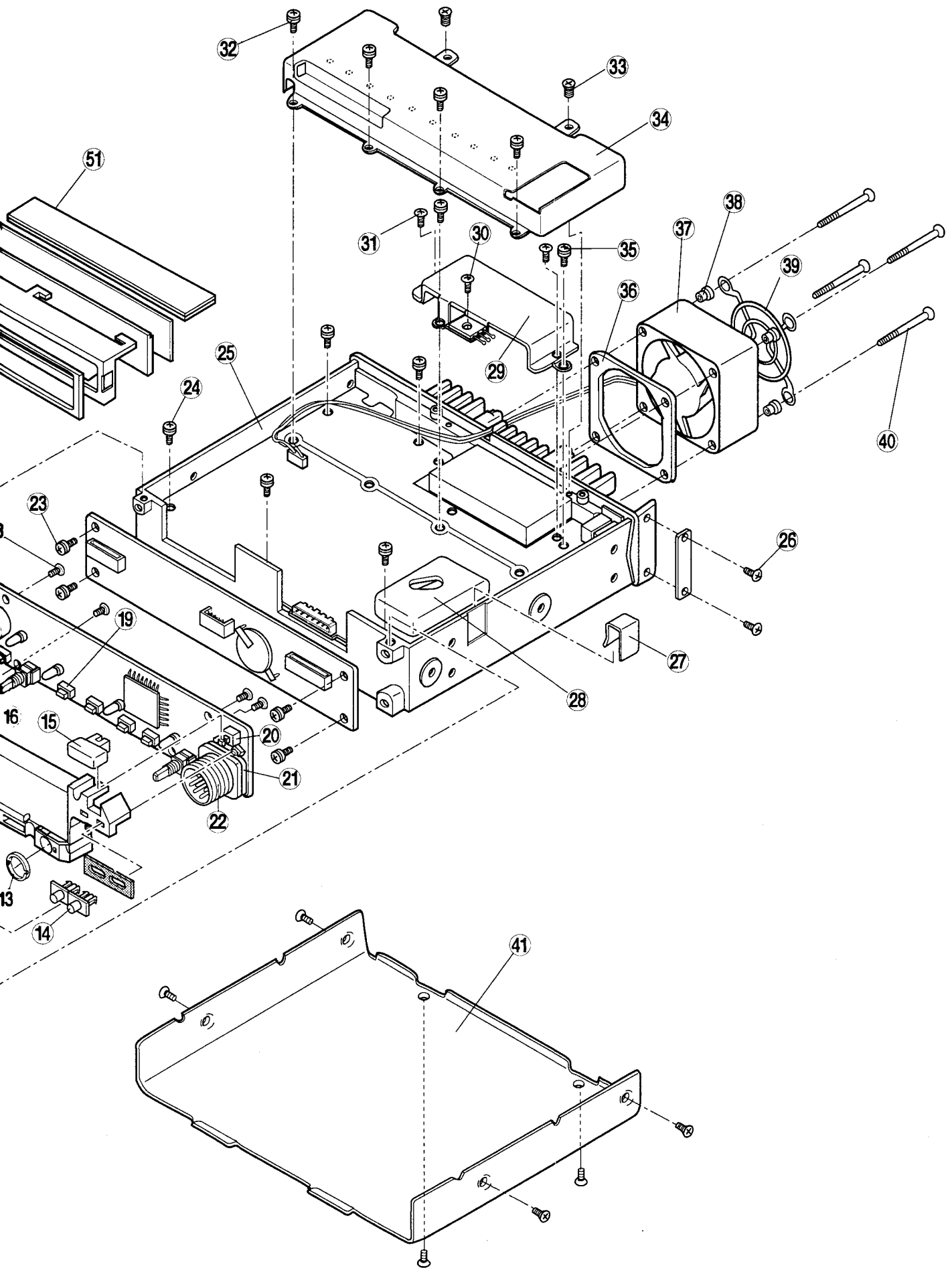

4-2 MAIN-B UNIT

LABEL NO.	ORDER NO.	DESCRIPTION	QTY.
①	8810003160	Setscrew (A) M3 x 6	12
②	8930001160	Ground spring	1
③	8510006411	833 VCO-B case-1	1
④	8930020670	U-module holder	1
⑤	8810003660	ICOM screw (A) 5	1
⑥	8810001910	Screw PH M3 x 6 BS NI	10
⑦	8950001840	Copper leaf emboss 25.4 L120	1
⑧	8810002100	Screw FH M2.6 x 4	2
⑨	8010012200	U-PA Shield (A)	1
⑩	6510013250	Connector LR-02F-1V	1
⑪	6510007650	Pin LLM61T-2.0	2
⑫	8900002700	Power supply cable OPC-249 (Incl. ⑩, ⑪)	1
⑬	8510006440	Antenna base cover	2
⑭	8900002450	OPC-223	1
⑮	6950000040	M-type cap (black)	1

Screw abbreviations PH: Pan head FH: Flat head BS: Brass NI: Nickel

4-3 ACCESSORIES

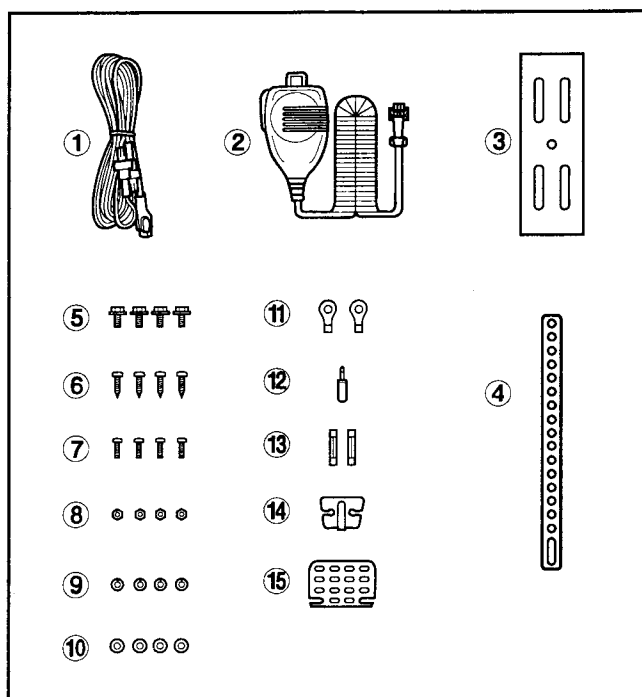

LABEL NO.	ORDER NO.	DESCRIPTION	QTY.
①	Optional product	DC power cable OPC-044B	1
②	Optional product	Microphone HM-56A (#25)	1
		Microphone HM-58 (#27, #28)	
		Microphone HM-59 (#22, #23)	
③	8010005180	Mounting bracket (B) ZK	1
④	8010004060	Mounting support bracket	1
⑤	8820000530	Mounting bolt	4
⑥	8810000950	Screw PH A M5 x 16	4
⑦	8810000470	Screw PH M5 x 12 (+ -)	4
⑧	8830000120	Nut M5	4
⑨	8850000440	Spring washer M5 NI	4
⑩	8850000150	Flat washer M5 NI BS	4
⑪	6510003070	Cable lugs R5.5-8	2
⑫	5610000020	AP313 3.5ø CS plug	1
⑬	5210000120	Fuse FGB 15A	2
⑭	8930007300	Microphone hanger	1
⑮	8310022240	Microphone sheet for HM-56A	1

Screw abbreviations PH: Pan head BS: Brass N: Nickel

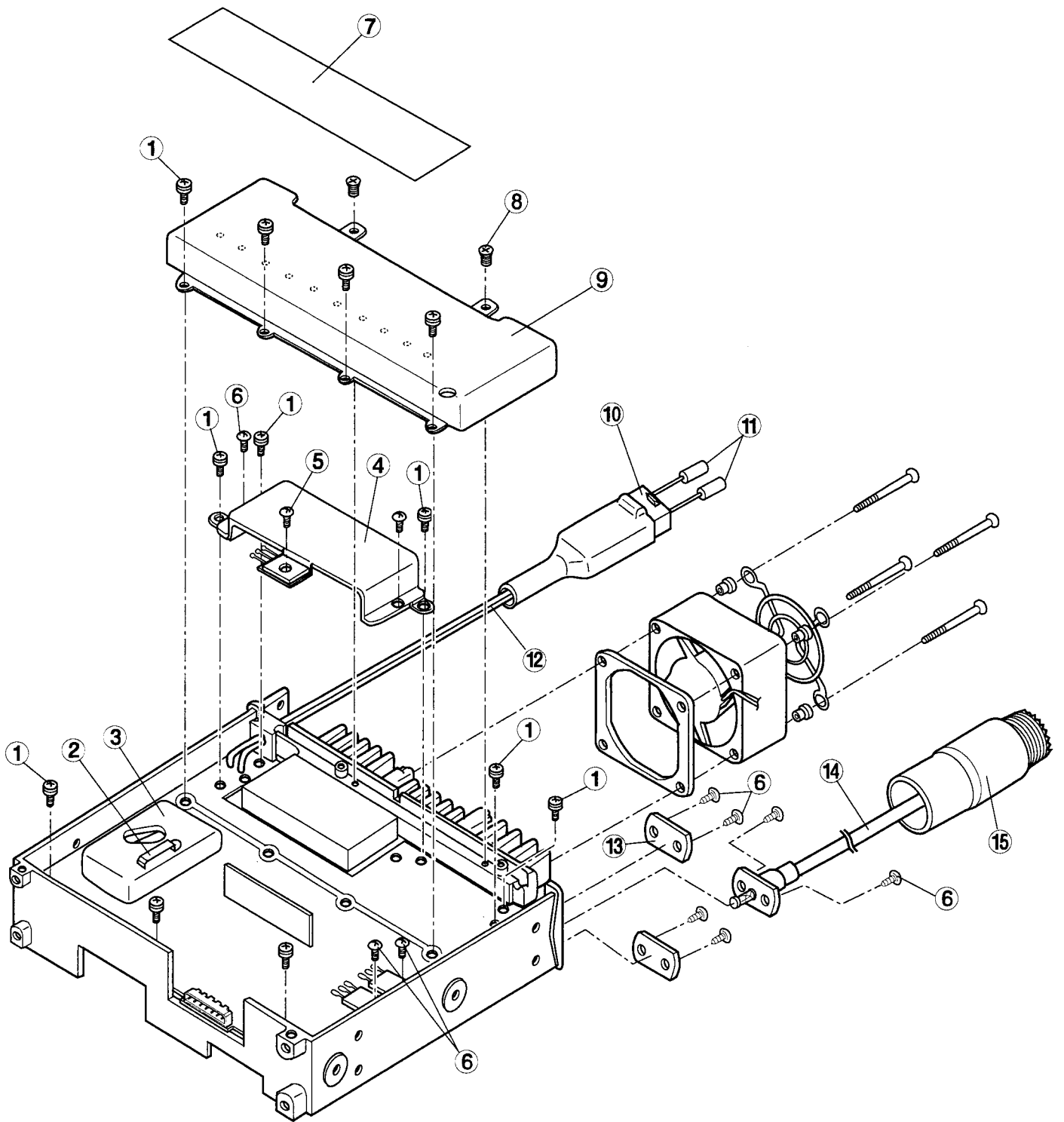

SECTION 5 PARTS LIST

[LOGIC UNIT]

REF. NO.	PARTS NO.	DESCRIPTION	
IC1	1130003920	S.IC	TC4S69F (TE85R)
IC2	1110001500	S.IC	S-8054ALR-LN-T1
IC3	1110000960	S.IC	NJM4558M(T1)
IC4	1140002310	S.IC	HD404019RB59FS
IC5	1120000430	S.IC	LA6393M-TP-T1
IC6	1130003920	S.IC	TC4S69F (TE85R)
Q1	1590000410	S.TRANSISTOR	RN2404 (TE85R)
Q2	1530000160	S.TRANSISTOR	2SC2712-Y (TE85RTEM)
Q3	1530000160	S.TRANSISTOR	2SC2712-Y (TE85RTEM)
Q4	1530000160	S.TRANSISTOR	2SC2712-Y (TE85RTEM)
Q5	1510000110	S.TRANSISTOR	2SA1162-Y (TE85R)
Q6	1530000160	S.TRANSISTOR	2SC2712-Y (TE85RTEM)
Q7	1590000380	S.FET	2SJ106-Y (TE85R)
Q8	1590000380	S.FET	2SJ106-Y (TE85R)
Q9	1590000420	S.TRANSISTOR	RN1404 (TE85R)
Q10	1530001950	S.TRANSISTOR	2SC2712-GR (TE85R)
Q11	1530001950	S.TRANSISTOR	2SC2712-GR (TE85R)
Q12	1590000380	S.FET	2SJ106-Y (TE85R)
Q13	1530001950	S.TRANSISTOR	2SC2712-GR (TE85R)
Q14	1590000380	S.FET	2SJ106-Y (TE85R)
Q15	1590000420	S.TRANSISTOR	RN1404 (TE85R)
Q16	1590000380	S.FET	2SJ106-Y (TE85R)
D1	1750000030	S.DIODE	1SS187 (TE85R)
D2	1750000010	S.DIODE	1SS181 (TE85R)
D3	1750000010	S.DIODE	1SS181 (TE85R) (#28)
	1750000030	S.DIODE	1SS187 (TE85R) (#22, #25)
	1750000040	S.DIODE	1SS190 (TE85R) (#27)
D4	1750000030	S.DIODE	1SS187 (TE85R) (#22)
	1750000040	S.DIODE	1SS190 (TE85R) (#23)
D5	1710000600	DIODE	1SS254 (#23, #25, #28)
D6	1710000600	DIODE	1SS254 (#23, #25, #28)
D7	1710000600	DIODE	1SS254 (#25, #28)
D9	1710000600	DIODE	1SS254 (#22, #23, #27, #28)
D10	1750000030	S.DIODE	1SS187 (TE85R) (#22, #27)
D11	1750000010	S.DIODE	1SS181 (TE85R) (#23)
	1750000040	S.DIODE	1SS190 (TE85R) (#25)
D12	1750000070	S.DIODE	1SS226 (TE85R)
X1	6060000230	CERAMIC	FAR-C4CA-04194000-M01
R1	7030003440	S.RESISTOR	ERJ3GEYJ 102 V (1K Ω)
R2	7030003680	S.RESISTOR	ERJ3GEYJ 104 V (100K Ω)
R3	7030003680	S.RESISTOR	ERJ3GEYJ 104 V (100K Ω)
R4	7030003680	S.RESISTOR	ERJ3GEYJ 104 V (100K Ω)
R5	7030003800	S.RESISTOR	ERJ3GEYJ 105 V (1M Ω)
R6	7030003560	S.RESISTOR	ERJ3GEYJ 103 V (10K Ω)
R7	7030003480	S.RESISTOR	ERJ3GEYJ 222 V (2.2K Ω)
R8	7030003610	S.RESISTOR	ERJ3GEYJ 273 V (27K Ω)
R9	7030003800	S.RESISTOR	ERJ3GEYJ 105 V (1M Ω)
R10	7030003560	S.RESISTOR	ERJ3GEYJ 103 V (10K Ω)
R11	7030003480	S.RESISTOR	ERJ3GEYJ 222 V (2.2K Ω)
R12	7030003640	S.RESISTOR	ERJ3GEYJ 473 V (47K Ω)
R13	7030003610	S.RESISTOR	ERJ3GEYJ 273 V (27K Ω)
R14	7030003680	S.RESISTOR	ERJ3GEYJ 104 V (100K Ω)
R15	7030003440	S.RESISTOR	ERJ3GEYJ 102 V (1K Ω)
R16	7030003640	S.RESISTOR	ERJ3GEYJ 473 V (47K Ω)
R17	7030003640	S.RESISTOR	ERJ3GEYJ 473 V (47K Ω)
R18	7030003720	S.RESISTOR	ERJ3GEYJ 224 V (220K Ω)

[LOGIC UNIT]

REF. NO.	PARTS NO.	DESCRIPTION	
R19	7030003520	S.RESISTOR	ERJ3GEYJ 472 V (4.7K Ω)
R20	7030003640	S.RESISTOR	ERJ3GEYJ 473 V (47K Ω)
R21	7030003520	S.RESISTOR	ERJ3GEYJ 472 V (4.7K Ω)
R22	7030003520	S.RESISTOR	ERJ3GEYJ 472 V (4.7K Ω)
R23	7030003520	S.RESISTOR	ERJ3GEYJ 472 V (4.7K Ω)
R24	7030003520	S.RESISTOR	ERJ3GEYJ 472 V (4.7K Ω)
R25	7030003620	S.RESISTOR	ERJ3GEYJ 333 V (33K Ω)
R26	7030003840	S.RESISTOR	ERJ3GEYJ 225 V (2.2M Ω)
R27	7030003440	S.RESISTOR	ERJ3GEYJ 102 V (1K Ω)
R28	7030003320	S.RESISTOR	ERJ3GEYJ 101 V (100 Ω)
R29	7030003470	S.RESISTOR	ERJ3GEYJ 182 V (1.8K Ω)
			(#22, #23, #27, #28)
	7030003520	S.RESISTOR	ERJ3GEYJ 472 V (4.7K Ω)
			(#25)
R30	7030003520	S.RESISTOR	ERJ3GEYJ 472 V (4.7K Ω)
			(#22, #23, #27, #28)
	7030003450	S.RESISTOR	ERJ3GEYJ 122 V (1.2K Ω)
			(#25)
R31	7030003570	S.RESISTOR	ERJ3GEYJ 123 V (12K Ω)
R32	7030003680	S.RESISTOR	ERJ3GEYJ 104 V (100K Ω)
R33	7030003840	S.RESISTOR	ERJ3GEYJ 225 V (2.2M Ω)
R34	7030003840	S.RESISTOR	ERJ3GEYJ 225 V (2.2M Ω)
R35	7030003680	S.RESISTOR	ERJ3GEYJ 104 V (100K Ω)
R36	7030003680	S.RESISTOR	ERJ3GEYJ 104 V (100K Ω)
R37	7030003680	S.RESISTOR	ERJ3GEYJ 104 V (100K Ω)
R38	7030003680	S.RESISTOR	ERJ3GEYJ 104 V (100K Ω)
R39	7030003320	S.RESISTOR	ERJ3GEYJ 101 V (100 Ω)
R40	4610001370	TRIMMER	EVM-L1GA00 B24 20KB
R41	7030003680	S.RESISTOR	ERJ3GEYJ 104 V (100K Ω)
R42	7030003600	S.RESISTOR	ERJ3GEYJ 223 V (22K Ω)
R43	7030003280	S.RESISTOR	ERJ3GEYJ 470 V (47 Ω)
R44	7030003420	S.RESISTOR	ERJ3GEYJ 681 V (680 Ω)
R45	7030003320	S.RESISTOR	ERJ3GEYJ 101 V (100 Ω)
R46	7030003740	S.RESISTOR	ERJ3GEYJ 334 V (330K Ω)
R47	7030003390	S.RESISTOR	ERJ3GEYJ 391 V (390 Ω)
R48	7030003750	S.RESISTOR	ERJ3GEYJ 394 V (390K Ω)
R49	7030003680	S.RESISTOR	ERJ3GEYJ 104 V (100K Ω)
R50	7030003680	S.RESISTOR	ERJ3GEYJ 104 V (100K Ω)
R51	7030003620	S.RESISTOR	ERJ3GEYJ 333 V (33K Ω)
R52	7030003520	S.RESISTOR	ERJ3GEYJ 472 V (4.7K Ω)
R53	7030003440	S.RESISTOR	ERJ3GEYJ 102 V (1K Ω)
R54	7030003790	S.RESISTOR	ERJ3GEYJ 824 V (820K Ω)
R55	7030003710	S.RESISTOR	ERJ3GEYJ 184 V (180K Ω)
R56	7030003550	S.RESISTOR	ERJ3GEYJ 822 V (8.2K Ω)
R57	7030003720	S.RESISTOR	ERJ3GEYJ 224 V (220K Ω)
R58	7030003670	S.RESISTOR	ERJ3GEYJ 823 V (82K Ω)
R59	7030003570	S.RESISTOR	ERJ3GEYJ 123 V (12K Ω)
R60	7030003670	S.RESISTOR	ERJ3GEYJ 823 V (82K Ω)
R61	7030003670	S.RESISTOR	ERJ3GEYJ 823 V (82K Ω)
R62	7030003450	S.RESISTOR	ERJ3GEYJ 122 V (1.2K Ω)
R63	7030003680	S.RESISTOR	ERJ3GEYJ 104 V (100K Ω)
R64	7030003640	S.RESISTOR	ERJ3GEYJ 473 V (47K Ω)
R65	7030003640	S.RESISTOR	ERJ3GEYJ 473 V (47K Ω)
R66	7030003640	S.RESISTOR	ERJ3GEYJ 473 V (47K Ω)
R67	7030003640	S.RESISTOR	ERJ3GEYJ 473 V (47K Ω)
R68	7030003640	S.RESISTOR	ERJ3GEYJ 473 V (47K Ω)
R69	7030003640	S.RESISTOR	ERJ3GEYJ 473 V (47K Ω)
R70	7030003800	S.RESISTOR	ERJ3GEYJ 105 V (1M Ω)
R71	7030003640	S.RESISTOR	ERJ3GEYJ 473 V (47K Ω)
R72	7030003640	S.RESISTOR	ERJ3GEYJ 473 V (47K Ω)
R73	7030003640	S.RESISTOR	ERJ3GEYJ 473 V (47K Ω)
R74	7030003640	S.RESISTOR	ERJ3GEYJ 473 V (47K Ω)
R75	7030003640	S.RESISTOR	ERJ3GEYJ 473 V (47K Ω)
R76	7030003640	S.RESISTOR	ERJ3GEYJ 473 V (47K Ω)

S. = Surface mount

[LOGIC UNIT]

REF. NO.	PARTS NO.	DESCRIPTION	
R77	7030003520	S.RESISTOR	ERJ3GEYJ 472 V (4.7KΩ)
R78	7030003640	S.RESISTOR	ERJ3GEYJ 473 V (47KΩ)
R79	7030003640	S.RESISTOR	ERJ3GEYJ 473 V (47KΩ)
R80	7030003640	S.RESISTOR	ERJ3GEYJ 473 V (47KΩ)
R81	7030003640	S.RESISTOR	ERJ3GEYJ 473 V (47KΩ)
R82	7030003720	S.RESISTOR	ERJ3GEYJ 224 V (220KΩ)
R83	7030003680	S.RESISTOR	ERJ3GEYJ 104 V (100KΩ)
R84	7030003640	S.RESISTOR	ERJ3GEYJ 473 V (47KΩ)
R85	7030003510	S.RESISTOR	ERJ3GEYJ 392 V (3.9KΩ)
R86	7030003550	S.RESISTOR	ERJ3GEYJ 822 V (8.2KΩ)
R87	7030003760	S.RESISTOR	ERJ3GEYJ 474 V (470KΩ)
R88	7030003760	S.RESISTOR	ERJ3GEYJ 474 V (470KΩ)
R89	7030003760	S.RESISTOR	ERJ3GEYJ 474 V (470KΩ)
R90	7030003640	S.RESISTOR	ERJ3GEYJ 473 V (47KΩ)
R91	7030003640	S.RESISTOR	ERJ3GEYJ 473 V (47KΩ)
R92	7030003640	S.RESISTOR	ERJ3GEYJ 473 V (47KΩ)
R93	7030003640	S.RESISTOR	ERJ3GEYJ 473 V (47KΩ)
R94	7030003640	S.RESISTOR	ERJ3GEYJ 473 V (47KΩ)
R95	7030003600	S.RESISTOR	ERJ3GEYJ 223 V (22KΩ)
R96	7030003640	S.RESISTOR	ERJ3GEYJ 473 V (47KΩ)
R97	7030003520	S.RESISTOR	ERJ3GEYJ 472 V (4.7KΩ)
R98	7030003520	S.RESISTOR	ERJ3GEYJ 472 V (4.7KΩ)
R99	7030003640	S.RESISTOR	ERJ3GEYJ 473 V (47KΩ)
R100	7030003640	S.RESISTOR	ERJ3GEYJ 473 V (47KΩ)
R101	7030003640	S.RESISTOR	ERJ3GEYJ 473 V (47KΩ)
R102	7030003640	S.RESISTOR	ERJ3GEYJ 473 V (47KΩ)
R103	7030003650	S.RESISTOR	ERJ3GEYJ 563 V (56KΩ)
R104	7030003680	S.RESISTOR	ERJ3GEYJ 104 V (100KΩ)
R105	7030003640	S.RESISTOR	ERJ3GEYJ 473 V (47KΩ)
R106	7030003520	S.RESISTOR	ERJ3GEYJ 472 V (4.7KΩ)
R107	7030003520	S.RESISTOR	ERJ3GEYJ 472 V (4.7KΩ)
R108	7030003520	S.RESISTOR	ERJ3GEYJ 472 V (4.7KΩ)
R109	7030003680	S.RESISTOR	ERJ3GEYJ 104 V (100KΩ)
R110	7030003680	S.RESISTOR	ERJ3GEYJ 104 V (100KΩ)
R111	7030003680	S.RESISTOR	ERJ3GEYJ 104 V (100KΩ)
R112	7030003680	S.RESISTOR	ERJ3GEYJ 104 V (100KΩ)
R113	7030003560	S.RESISTOR	ERJ3GEYJ 103 V (10KΩ)
R114	7030003600	S.RESISTOR	ERJ3GEYJ 223 V (22KΩ)
R115	7030003660	S.RESISTOR	ERJ3GEYJ 683 V (68KΩ)
R116	7030003640	S.RESISTOR	ERJ3GEYJ 473 V (47KΩ)
R117	7030003800	S.RESISTOR	ERJ3GEYJ 105 V (1MΩ)
R118	7030003800	S.RESISTOR	ERJ3GEYJ 105 V (1MΩ)
R119	7030003640	S.RESISTOR	ERJ3GEYJ 473 V (47KΩ)
R120	7030003640	S.RESISTOR	ERJ3GEYJ 473 V (47KΩ)
R121	7030003640	S.RESISTOR	ERJ3GEYJ 473 V (47KΩ)
C1	4030008630	S.CERAMIC	C1608 JF 1C 104Z-T-A
C2	4030008630	S.CERAMIC	C1608 JF 1C 104Z-T-A
C3	4030008630	S.CERAMIC	C1608 JF 1C 104Z-T-A
C4	4030008630	S.CERAMIC	C1608 JF 1C 104Z-T-A
C5	4030008630	S.CERAMIC	C1608 JF 1C 104Z-T-A
C6	4030008630	S.CERAMIC	C1608 JF 1C 104Z-T-A
C7	4030008630	S.CERAMIC	C1608 JF 1C 104Z-T-A
C8	4030008680	S.CERAMIC	C2012 JF 1C 105Z-T-A
C9	4030005090	S.CERAMIC	C2012 JB 1H 223K-T-A
C10	4510001370	ELECTROL	16 MS5 47μF
C11	4510001350	ELECTROL	16 MS5 10μF
C12	4030008630	S.CERAMIC	C1608 JF 1C 104Z-T-A
C13	4030008630	S.CERAMIC	C1608 JF 1C 104Z-T-A
C14	4030006870	S.CERAMIC	C1608 JB 1H 222K-T-A
C15	4030005110	S.CERAMIC	C2012 JB 1E 473K-T-A
C16	4030005110	S.CERAMIC	C2012 JB 1E 473K-T-A
C17	4510001470	ELECTROL	50 MS5 1μF
C18	4030008630	S.CERAMIC	C1608 JF 1C 104Z-T-A
C19	4030008630	S.CERAMIC	C1608 JF 1C 104Z-T-A
C20	4030008630	S.CERAMIC	C1608 JF 1C 104Z-T-A
C21	4030007020	S.CERAMIC	C1608 CH 1H 120J-T-A
C22	4030008630	S.CERAMIC	C1608 JF 1C 104Z-T-A
C23	4030008630	S.CERAMIC	C1608 JF 1C 104Z-T-A
C24	4550002950	S.TANTALUM	TESVA OJ 335M1-8L

[LOGIC UNIT]

REF. NO.	PARTS NO.	DESCRIPTION	
C25	4030008680	S.CERAMIC	C2012 JF 1C 105Z-T-A
C26	4030008680	S.CERAMIC	C2012 JF 1C 105Z-T-A
C27	4030008690	S.CERAMIC	C2012 SL 1H 821J-T-A
C28	4030008630	S.CERAMIC	C1608 JF 1C 104Z-T-A
C29	4030008650	S.CERAMIC	C1608 JB 1H 332K-T-A
C30	4030006740	S.CERAMIC	C1608 SL 1H 820J-T-A
C31	4510001370	ELECTROL	16 MS5 47μF
C32	4030006750	S.CERAMIC	C1608 SL 1H 101J-T-A
C33	4030008630	S.CERAMIC	C1608 JF 1C 104Z-T-A
C34	4030008630	S.CERAMIC	C1608 JF 1C 104Z-T-A
C35	4030008630	S.CERAMIC	C1608 JF 1C 104Z-T-A
C36	4510001370	ELECTROL	16 MS5 47μF
C37	4030008630	S.CERAMIC	C1608 JF 1C 104Z-T-A
C38	4550000530	S.TANTALUM	TESVA 1V 104M1-8L
C39	4030008630	S.CERAMIC	C1608 JF 1C 104Z-T-A
C40	4030008660	S.CERAMIC	C2012 JB 1H 333K-T-A
C41	4030008680	S.CERAMIC	C2012 JF 1C 105Z-T-A
C42	4030006860	S.CERAMIC	C1608 JB 1H 102K-T-A
C43	4030006860	S.CERAMIC	C1608 JB 1H 102K-T-A
BT1	3020000100	LITHIUM	CR2025-1T21
EP1	910033741	PCB	B 3285A

[VR-A UNIT]

REF. NO.	PARTS NO.	DESCRIPTION	
R1	7210001910	VARIABLE	RV-199 (RK0972210) 10KB*10KA
EP1	910033523	PCB	B 3286C

[VR-B UNIT]

REF. NO.	PARTS NO.	DESCRIPTION	
R1	7210001910	VARIABLE	RV-199 (RK0972210) 10KB*10KA
EP1	910033523	PCB	B 3286C

[DISPLAY UNIT]

REF. NO.	PARTS NO.	DESCRIPTION	
IC1	1130004190	S.IC	LC7582A
IC2	1130004190	S.IC	LC7582A
Q1	1510000690	S.TRANSISTOR	2SA1734 (TE12R)
Q2	1510000690	S.TRANSISTOR	2SA1734 (TE12R)
Q3	1530000160	S.TRANSISTOR	2SC2712-Y (TE85RTEM)
Q4	1530000160	S.TRANSISTOR	2SC2712-Y (TE85RTEM)
Q5	1530000160	S.TRANSISTOR	2SC2712-Y (TE85RTEM)
D1	1750000010	S.DIODE	1SS181 (TE85R)
D2	1750000010	S.DIODE	1SS181 (TE85R)

S. = Surface mount

[DISPLAY UNIT]

[MAIN-A UNIT]

REF. NO.	PARTS NO.	DESCRIPTION	
D3	1750000010	S.DIODE	1SS181 (TE85R)
D4	1750000010	S.DIODE	1SS181 (TE85R)
D5	1750000060	S.DIODE	1SS196 (TE85R)
D6	1730000840	S.ZENER	RD9.1M-T2B2
D7	1730000840	S.ZENER	RD9.1M-T2B2
R1	7030003650	S.RESISTOR	ERJ3GEYJ 563 V (56KΩ)
R2	7030003650	S.RESISTOR	ERJ3GEYJ 563 V (56KΩ)
R3	7030000020	S.RESISTOR	MCR10EZHZ 1 Ω (010)
R4	7030000230	S.RESISTOR	MCR10EZHZ 56 Ω (560)
R5	7030000020	S.RESISTOR	MCR10EZHZ 1 Ω (010)
R6	7030000140	S.RESISTOR	MCR10EZHZ 10 Ω (100)
R7	7030000220	S.RESISTOR	MCR10EZHZ 47 Ω (470)
R8	7030001130	S.RESISTOR	MCR50JZHJ 100 Ω (101)
R9	7030001130	S.RESISTOR	MCR50JZHJ 100 Ω (101)
R10	7030003500	S.RESISTOR	ERJ3GEYJ 332 V (3.3KΩ)
R11	7030003500	S.RESISTOR	ERJ3GEYJ 332 V (3.3KΩ)
R12	7030003450	S.RESISTOR	ERJ3GEYJ 122 V (1.2KΩ)
R13	7030003560	S.RESISTOR	ERJ3GEYJ 103 V (10KΩ)
R14	7030003560	S.RESISTOR	ERJ3GEYJ 103 V (10KΩ)
R15	7030003560	S.RESISTOR	ERJ3GEYJ 103 V (10KΩ)
R16	7030003560	S.RESISTOR	ERJ3GEYJ 103 V (10KΩ)
R17	7030003560	S.RESISTOR	ERJ3GEYJ 103 V (10KΩ)
R18	7030003200	S.RESISTOR	ERJ3GEYJ 100 V (10Ω)
R19	7030003600	S.RESISTOR	ERJ3GEYJ 223 V (22KΩ)
R20	7030003560	S.RESISTOR	ERJ3GEYJ 103 V (10KΩ)
R21	7030003480	S.RESISTOR	ERJ3GEYJ 222 V (2.2KΩ)
R22	7030003680	S.RESISTOR	ERJ3GEYJ 104 V (100KΩ)
R23	7030003560	S.RESISTOR	ERJ3GEYJ 103 V (10KΩ)
R24	7030003800	S.RESISTOR	ERJ3GEYJ 105 V (1MΩ)
R25	7030003480	S.RESISTOR	ERJ3GEYJ 222 V (2.2KΩ)
R26	7030003560	S.RESISTOR	ERJ3GEYJ 103 V (10KΩ)
C1	4030006830	S.CERAMIC	C1608 SL 1H 331J-T-A
C2	4030006860	S.CERAMIC	C1608 JB 1H 102K-T-A
C3	4030006830	S.CERAMIC	C1608 SL 1H 331J-T-A
C4	4030006860	S.CERAMIC	C1608 JB 1H 102K-T-A
C5	4030006860	S.CERAMIC	C1608 JB 1H 102K-T-A
C6	4030006860	S.CERAMIC	C1608 JB 1H 102K-T-A
C7	4030006860	S.CERAMIC	C1608 JB 1H 102K-T-A
C8	4030006860	S.CERAMIC	C1608 JB 1H 102K-T-A
C9	4030006860	S.CERAMIC	C1608 JB 1H 102K-T-A
C10	4030006860	S.CERAMIC	C1608 JB 1H 102K-T-A
C11	4030006860	S.CERAMIC	C1608 JB 1H 102K-T-A
C12	4030006860	S.CERAMIC	C1608 JB 1H 102K-T-A
C13	4030008630	S.CERAMIC	C1608 JF 1C 104Z-T-A
C14	4030008630	S.CERAMIC	C1608 JF 1C 104Z-T-A
C15	4030008630	S.CERAMIC	C1608 JF 1C 104Z-T-A
DS1	5030000750	LCD	FTD-10788AAH
DS2	5080000150	LAMP	HRS-7219A
DS3	5080000150	LAMP	HRS-7219A
DS4	5080000150	LAMP	HRS-7219A
DS5	5080000150	LAMP	HRS-7219A
DS6	5080000150	LAMP	HRS-7219A
S1	2250000050	ENCODER	EVQ-WQGF15 24B
S2	2260000580	SWITCH	SKHLAD035A
S3	2260000580	SWITCH	SKHLAD035A
S4	2260000580	SWITCH	SKHLAD035A
S5	2260000580	SWITCH	SKHLAD035A
S6	2260000580	SWITCH	SKHLAD035A
S7	2260000580	SWITCH	SKHLAD035A
S8	2260000580	SWITCH	SKHLAD035A
S9	2260000580	SWITCH	SKHLAD035A
S10	2230000550	SWITCH	SPPH23079A
EP1	910033672	PCB	B 3284B 2(FX1129)

REF. NO.	PARTS NO.	DESCRIPTION	
IC1	1130004200	S.IC	TC4S66F (TE85R)
IC2	1150000920	IC	SC1124 (IC-3230A/E)
	1150000910	IC	SC1125 (IC-3230H)
IC3	1110001240	S.IC	μPC358G2-T1
IC4	1110002200	S.IC	MC3372MR
IC5	1130004730	S.IC	BU4066BF-T1
IC6	1130005810	S.IC	BU4094BF-T1
IC7	1130005810	S.IC	BU4094BF-T1
IC8	1130003760	S.IC	TC4S81F (TE85R)
IC9	1110002540	IC	LA4445
Q1	1530000160	S.TRANSISTOR	2SC2712-Y (TE85RTEM)
Q2	1510000690	S.TRANSISTOR	2SA1734 (TE12R)
Q3	1530002050	S.TRANSISTOR	2SC3661-TA
Q4	1530002030	S.TRANSISTOR	2SC3772-3-TA
Q5	1560000360	S.FET	2SK209-Y (TE85R)
Q6	1510000110	S.TRANSISTOR	2SA1162-Y (TE85R)
Q7	1530002030	S.TRANSISTOR	2SC3772-3-TA
Q8	1530000640	TRANSISTOR	2SC2407(A) (IC-3230A/E)
	1590000390	TRANSISTOR	MRF-559 (IC-3230H)
Q9	1590000420	S.TRANSISTOR	RN1404 (TE85R)
Q10	1590000420	S.TRANSISTOR	RN1404 (TE85R)
Q11	1520000380	TRANSISTOR	2SB1143 S (IC-3230A/E)
	1520000390	TRANSISTOR	2SB1135 R (IC-3230H)
Q12	1530000160	S.TRANSISTOR	2SC2712-Y (TE85RTEM)
Q13	1590000380	S.FET	2SJ106-Y (TE85R)
Q14	1530002030	S.TRANSISTOR	2SC3772-3-TA
Q15	1530000160	S.TRANSISTOR	2SC2712-Y (TE85RTEM)
Q16	1530001950	S.TRANSISTOR	2SC2712-GR (TE85R)
Q17	1530001950	S.TRANSISTOR	2SC2712-GR (TE85R)
Q18	1590000830	S.TRANSISTOR	FMG2 T149
Q19	1580000350	S.FET	3SK140-Y (TE85R)
Q20	1530002030	S.TRANSISTOR	2SC3772-3-TA
Q21	1580000360	S.FET	3SK177-T2B U73
Q22	1590000420	S.TRANSISTOR	RN1404 (TE85R)
Q23	1590000690	S.TRANSISTOR	IMD6 T108
Q24	1590000460	S.TRANSISTOR	RN1402 (TE85R)
Q25	1590000460	S.TRANSISTOR	RN1402 (TE85R)
Q26	1590001000	S.TRANSISTOR	RN2427 (TE85R)
Q27	1590001000	S.TRANSISTOR	RN2427 (TE85R)
Q28	1530000160	S.TRANSISTOR	2SC2712-Y (TE85RTEM)
Q29	1530000160	S.TRANSISTOR	2SC2712-Y (TE85RTEM)
Q30	1530000160	S.TRANSISTOR	2SC2712-Y (TE85RTEM)
Q31	1530000160	S.TRANSISTOR	2SC2712-Y (TE85RTEM)
Q32	1530000160	S.TRANSISTOR	2SC2712-Y (TE85RTEM)
Q33	1530000160	S.TRANSISTOR	2SC2712-Y (TE85RTEM)
Q34	1530002550	S.TRANSISTOR	2SC3326-B (TE85R)
Q35	1530002550	S.TRANSISTOR	2SC3326-B (TE85R)
Q36	1530002550	S.TRANSISTOR	2SC3326-B (TE85R)
Q37	1530000160	S.TRANSISTOR	2SC2712-Y (TE85RTEM)
Q38	1520000200	S.TRANSISTOR	2SB798-T2 DK
D1	1750000060	S.DIODE	1SS196 (TE85R)
D3	1750000080	S.DIODE	1SS153-T2
D4	1750000080	S.DIODE	1SS153-T2
D5	1750000060	S.DIODE	1SS196 (TE85R)
D6	1790000490	S.DIODE	HSM88AS-TR
D7	1790000490	S.DIODE	HSM88AS-TR
D8	1710000290	DIODE	MI308
D9	1710000290	DIODE	MI308
D10	1710000290	DIODE	MI308
D11	1750000070	S.DIODE	1SS226 (TE85R)
D12	1750000060	S.DIODE	1SS196 (TE85R)
D13	1730000730	S.ZENER	RD6.2M-T2B2
D14	1750000070	S.DIODE	1SS226 (TE85R)
D15	1790000490	S.DIODE	HSM88AS-TR
D16	1790000450	S.DIODE	MA862(TX)
D17	1720000220	S.VARICAP	1SV166-T2B
D18	1720000220	S.VARICAP	1SV166-T2B

S. = Surface mount

[MAIN-A UNIT]

REF. NO.	PARTS NO.	DESCRIPTION	
D19	1720000220	S.VARICAP	1SV166-T2B
D20	1720000220	S.VARICAP	1SV166-T2B
D21	1790000450	S.DIODE	MA862(TX)
D22	1750000020	S.DIODE	1SS184 (TE85R)
D23	1730000730	S.ZENER	RD6.2M-T2B2
X1	6070000080	DISCRI	CDBM455C16
X2	6050003010	XTAL	CR-166
F11	2020000550	CERAMIC	CFUM455E
F12	2010000580	FILTER	17M15B (FL-78)
L1	6200000830	S.COIL	LQH 3N 3R3M
L2	6200000891	S.COIL	NL 322522T-R15M-3
L3	6200000770	S.COIL	LQN 2A 68NM
L4	6200000130	S.COIL	LQN 2A 47NM
L5	6110001610	COIL	LA-244 (IC-3230A/E)
	6110001680	COIL	LA-254 (IC-3230H)
L6	6110001530	COIL	LA-233 (IC-3230A/E)
	6110001550	COIL	LA-235 (IC-3230H)
L7	6110001540	COIL	LA-234
L8	6170000180	COIL	LW-19
L9	6110001610	COIL	LA-244
L10	6110001620	COIL	LA-245
L11	6110001610	COIL	LA-244
L12	6110001550	COIL	LA-235
L13	6110001550	COIL	LA-235
L14	6200000020	S.COIL	LQH 3N 101K-S
L15	6150003150	COIL	LS-331
L16	6150003150	COIL	LS-331
L17	6150002810	COIL	LS-291
L18	6150002810	COIL	LS-291
L19	6150002810	COIL	LS-291
L20	6150002810	COIL	LS-291
L21	6150003120	COIL	LS-321
L22	6150003120	COIL	LS-321
R1	7030003640	S.RESISTOR	ERJ3GEYJ 473 V (47KΩ)
R2	7030003560	S.RESISTOR	ERJ3GEYJ 103 V (10KΩ)
R3	7030003480	S.RESISTOR	ERJ3GEYJ 222 V (2.2KΩ)
R4	7030003560	S.RESISTOR	ERJ3GEYJ 103 V (10KΩ)
R5	4610001110	TRIMMER	EVM-LGGA00 B15 (104)
R6	7030003320	S.RESISTOR	ERJ3GEYJ 101 V (100Ω)
R7	7030003680	S.RESISTOR	ERJ3GEYJ 104 V (100KΩ)
R8	7030003400	S.RESISTOR	ERJ3GEYJ 471 V (470Ω)
R9	7030003400	S.RESISTOR	ERJ3GEYJ 471 V (470Ω)
R10	7030003520	S.RESISTOR	ERJ3GEYJ 472 V (4.7KΩ)
R11	7030003220	S.RESISTOR	ERJ3GEYJ 150 V (15Ω)
R12	7030003400	S.RESISTOR	ERJ3GEYJ 471 V (470Ω)
R13	7030003520	S.RESISTOR	ERJ3GEYJ 472 V (4.7KΩ)
R14	7030003480	S.RESISTOR	ERJ3GEYJ 222 V (2.2KΩ)
R15	7030003800	S.RESISTOR	ERJ3GEYJ 105 V (1MΩ)
R16	7030003720	S.RESISTOR	ERJ3GEYJ 224 V (220KΩ)
R17	7030003200	S.RESISTOR	ERJ3GEYJ 100 V (10Ω)
R18	7030003520	S.RESISTOR	ERJ3GEYJ 472 V (4.7KΩ)
R19	7030003420	S.RESISTOR	ERJ3GEYJ 681 V (680Ω)
R20	7030003700	S.RESISTOR	ERJ3GEYJ 154 V (150KΩ)
R21	7030003680	S.RESISTOR	ERJ3GEYJ 104 V (100KΩ)
R22	7030003280	S.RESISTOR	ERJ3GEYJ 470 V (47Ω)
R23	7030003370	S.RESISTOR	ERJ3GEYJ 271 V (270Ω)
R24	7030003230	S.RESISTOR	ERJ3GEYJ 180 V (18Ω)
R25	7030003370	S.RESISTOR	ERJ3GEYJ 271 V (270Ω)
R26	7030003440	S.RESISTOR	ERJ3GEYJ 102 V (1KΩ)
R27	7030003500	S.RESISTOR	ERJ3GEYJ 332 V (3.3KΩ)
R28	7030003440	S.RESISTOR	ERJ3GEYJ 102 V (1KΩ)
R29	7030003320	S.RESISTOR	ERJ3GEYJ 101 V (100Ω)
R30	4610001100	TRIMMER	EVM-LGGA00 B34 (303)

[MAIN-A UNIT]

REF. NO.	PARTS NO.	DESCRIPTION	
R31	7030003570	S.RESISTOR	ERJ3GEYJ 123 V (12KΩ)
R32	7030003490	S.RESISTOR	ERJ3GEYJ 272 V (2.7KΩ)
R33	7030003280	S.RESISTOR	ERJ3GEYJ 470 V (47Ω)
R34	7030003450	S.RESISTOR	ERJ3GEYJ 122 V (1.2KΩ)
R35	7030001010	S.RESISTOR	MCR50JZHJ 10 Ω (100)
R36	7030003550	S.RESISTOR	ERJ3GEYJ 822 V (8.2KΩ) (IC-3230A/E)
	7030003530	S.RESISTOR	ERJ3GEYJ 562 V (5.6KΩ) (IC-3230H)
R37	7030001150	S.RESISTOR	MCR50JZHJ 150 Ω (151)
R38	7030001190	S.RESISTOR	MCR50JZHJ 330 Ω (331)
R39	7030003460	S.RESISTOR	ERJ3GEYJ 152 V (1.5KΩ) (IC-3230A/E)
	7030003480	S.RESISTOR	ERJ3GEYJ 222 V (2.2KΩ) (IC-3230H)
R40	7030003340	S.RESISTOR	ERJ3GEYJ 151 V (150Ω)
R41	7030003620	S.RESISTOR	ERJ3GEYJ 333 V (33KΩ)
R42	7030003640	S.RESISTOR	ERJ3GEYJ 473 V (47KΩ)
R43	7030003460	S.RESISTOR	ERJ3GEYJ 152 V (1.5KΩ) (IC-3230A/E)
	7030003480	S.RESISTOR	ERJ3GEYJ 222 V (2.2KΩ) (IC-3230H)
R44	7030003340	S.RESISTOR	ERJ3GEYJ 151 V (150Ω)
R45	7030003560	S.RESISTOR	ERJ3GEYJ 103 V (10KΩ)
R46	7030001130	S.RESISTOR	MCR50JZHJ 100 Ω (101)
R47	7030003790	S.RESISTOR	ERJ3GEYJ 824 V (820KΩ)
R48	7030003320	S.RESISTOR	ERJ3GEYJ 101 V (100Ω)
R49	7030003600	S.RESISTOR	ERJ3GEYJ 223 V (22KΩ)
R50	7030003320	S.RESISTOR	ERJ3GEYJ 101 V (100Ω)
R51	7030003640	S.RESISTOR	ERJ3GEYJ 473 V (47KΩ)
R52	7030003570	S.RESISTOR	ERJ3GEYJ 123 V (12KΩ)
R53	7030003720	S.RESISTOR	ERJ3GEYJ 224 V (220KΩ)
R54	7030003640	S.RESISTOR	ERJ3GEYJ 473 V (47KΩ)
R55	7030003640	S.RESISTOR	ERJ3GEYJ 473 V (47KΩ)
R56	7030003570	S.RESISTOR	ERJ3GEYJ 123 V (12KΩ)
R57	7030003530	S.RESISTOR	ERJ3GEYJ 562 V (5.6KΩ)
R58	7030003470	S.RESISTOR	ERJ3GEYJ 182 V (1.8KΩ)
R59	7030003600	S.RESISTOR	ERJ3GEYJ 223 V (22KΩ)
R60	7030003640	S.RESISTOR	ERJ3GEYJ 473 V (47KΩ)
R61	7030003640	S.RESISTOR	ERJ3GEYJ 473 V (47KΩ)
R62	7030003640	S.RESISTOR	ERJ3GEYJ 473 V (47KΩ)
R63	7030003400	S.RESISTOR	ERJ3GEYJ 471 V (470Ω)
R64	7030003320	S.RESISTOR	ERJ3GEYJ 101 V (100Ω)
R65	7030003760	S.RESISTOR	ERJ3GEYJ 474 V (470KΩ)
R66	7030003430	S.RESISTOR	ERJ3GEYJ 821 V (820Ω)
R67	7030003320	S.RESISTOR	ERJ3GEYJ 101 V (100Ω)
R68	7030003320	S.RESISTOR	ERJ3GEYJ 101 V (100Ω)
R69	7030003400	S.RESISTOR	ERJ3GEYJ 471 V (470Ω)
R70	7030003520	S.RESISTOR	ERJ3GEYJ 472 V (4.7KΩ)
R71	7030003480	S.RESISTOR	ERJ3GEYJ 222 V (2.2KΩ)
R72	7030003680	S.RESISTOR	ERJ3GEYJ 104 V (100KΩ)
R73	7030003700	S.RESISTOR	ERJ3GEYJ 154 V (150KΩ)
R74	7030003520	S.RESISTOR	ERJ3GEYJ 472 V (4.7KΩ)
R75	4610001110	TRIMMER	EVM-LGGA00 B15 (104)
R76	7030003440	S.RESISTOR	ERJ3GEYJ 102 V (1KΩ)
R77	7030003840	S.RESISTOR	ERJ3GEYJ 225 V (2.2MΩ)
R78	7030003470	S.RESISTOR	ERJ3GEYJ 182 V (1.8KΩ)
R79	7030003520	S.RESISTOR	ERJ3GEYJ 472 V (4.7KΩ)
R80	7030003490	S.RESISTOR	ERJ3GEYJ 272 V (2.7KΩ)
R81	7030003700	S.RESISTOR	ERJ3GEYJ 154 V (150KΩ)
R82	7030003320	S.RESISTOR	ERJ3GEYJ 101 V (100Ω)
R83	7030003370	S.RESISTOR	ERJ3GEYJ 271 V (270Ω)
R84	7030003560	S.RESISTOR	ERJ3GEYJ 103 V (10KΩ)
R85	7030003550	S.RESISTOR	ERJ3GEYJ 822 V (8.2KΩ)
R86	7030003560	S.RESISTOR	ERJ3GEYJ 103 V (10KΩ)
R87	7030003680	S.RESISTOR	ERJ3GEYJ 104 V (100KΩ)
R88	7030003560	S.RESISTOR	ERJ3GEYJ 103 V (10KΩ)
R89	7030003680	S.RESISTOR	ERJ3GEYJ 104 V (100KΩ)
R90	7030003680	S.RESISTOR	ERJ3GEYJ 104 V (100KΩ)
R91	7030003440	S.RESISTOR	ERJ3GEYJ 102 V (1KΩ)
R92	7030003320	S.RESISTOR	ERJ3GEYJ 101 V (100Ω)

S. = Surface mount

[MAIN-A UNIT]

REF. NO.	PARTS NO.	DESCRIPTION
R93	7030003280	S.RESISTOR ERJ3GEYJ 470 V (47Ω)
R94	7030003280	S.RESISTOR ERJ3GEYJ 470 V (47Ω)
R95	7030003650	S.RESISTOR ERJ3GEYJ 563 V (56KΩ)
R96	7030003680	S.RESISTOR ERJ3GEYJ 104 V (100KΩ)
R97	7030003200	S.RESISTOR ERJ3GEYJ 100 V (10Ω)
R98	7030003230	S.RESISTOR ERJ3GEYJ 180 V (18Ω)
R99	7030003560	S.RESISTOR ERJ3GEYJ 103 V (10KΩ)
R100	7030003610	S.RESISTOR ERJ3GEYJ 273 V (27KΩ)
R101	7030003680	S.RESISTOR ERJ3GEYJ 104 V (100KΩ)
R102	7030003680	S.RESISTOR ERJ3GEYJ 104 V (100KΩ)
R103	7030003560	S.RESISTOR ERJ3GEYJ 103 V (10KΩ)
R104	7030003560	S.RESISTOR ERJ3GEYJ 103 V (10KΩ)
R105	7030003760	S.RESISTOR ERJ3GEYJ 474 V (470KΩ)
R106	7030003760	S.RESISTOR ERJ3GEYJ 474 V (470KΩ)
R107	7030003760	S.RESISTOR ERJ3GEYJ 474 V (470KΩ)
R108	7030003760	S.RESISTOR ERJ3GEYJ 474 V (470KΩ)
R109	7030003760	S.RESISTOR ERJ3GEYJ 474 V (470KΩ)
R110	7030003680	S.RESISTOR ERJ3GEYJ 104 V (100KΩ)
R111	7030003760	S.RESISTOR ERJ3GEYJ 474 V (470KΩ)
R112	7030003320	S.RESISTOR ERJ3GEYJ 101 V (100Ω)
R113	7030003440	S.RESISTOR ERJ3GEYJ 102 V (1KΩ)
R114	7030003480	S.RESISTOR ERJ3GEYJ 222 V (2.2KΩ)
R115	7030003440	S.RESISTOR ERJ3GEYJ 102 V (1KΩ)
R116	7030003640	S.RESISTOR ERJ3GEYJ 473 V (47KΩ)
R117	7030003480	S.RESISTOR ERJ3GEYJ 222 V (2.2KΩ)
R118	7030003640	S.RESISTOR ERJ3GEYJ 473 V (47KΩ)
R119	7030003760	S.RESISTOR ERJ3GEYJ 474 V (470KΩ)
R120	7030003760	S.RESISTOR ERJ3GEYJ 474 V (470KΩ)
R121	7030003600	S.RESISTOR ERJ3GEYJ 223 V (22KΩ)
R122	7030003600	S.RESISTOR ERJ3GEYJ 223 V (22KΩ)
R123	7030003480	S.RESISTOR ERJ3GEYJ 222 V (2.2KΩ)
R124	7030003380	S.RESISTOR ERJ3GEYJ 331 V (330Ω)
R125	7030003480	S.RESISTOR ERJ3GEYJ 222 V (2.2KΩ)
R126	7030003380	S.RESISTOR ERJ3GEYJ 331 V (330Ω)
R127	7030003760	S.RESISTOR ERJ3GEYJ 474 V (470KΩ)
R128	7030003760	S.RESISTOR ERJ3GEYJ 474 V (470KΩ)
R129	7030003480	S.RESISTOR ERJ3GEYJ 222 V (2.2KΩ)
R130	7030003560	S.RESISTOR ERJ3GEYJ 103 V (10KΩ)
R131	7030003740	S.RESISTOR ERJ3GEYJ 334 V (330KΩ)
R132	7030003280	S.RESISTOR ERJ3GEYJ 470 V (47Ω)
R133	7030003500	S.RESISTOR ERJ3GEYJ 332 V (3.3KΩ)
R134	7030003650	S.RESISTOR ERJ3GEYJ 563 V (56KΩ)
R135	7030003630	S.RESISTOR ERJ3GEYJ 393 V (39KΩ)
R136	7030003600	S.RESISTOR ERJ3GEYJ 223 V (22KΩ)
R137	7030003560	S.RESISTOR ERJ3GEYJ 103 V (10KΩ)
R138	7030003440	S.RESISTOR ERJ3GEYJ 102 V (1KΩ)
R139	7030003480	S.RESISTOR ERJ3GEYJ 222 V (2.2KΩ)
R140	7030003560	S.RESISTOR ERJ3GEYJ 103 V (10KΩ)
R141	7030003740	S.RESISTOR ERJ3GEYJ 334 V (330KΩ)
R142	7030003500	S.RESISTOR ERJ3GEYJ 332 V (3.3KΩ)
R143	7030003650	S.RESISTOR ERJ3GEYJ 563 V (56KΩ)
R144	7030003280	S.RESISTOR ERJ3GEYJ 470 V (47Ω)
R145	7030003630	S.RESISTOR ERJ3GEYJ 393 V (39KΩ)
R146	7030003600	S.RESISTOR ERJ3GEYJ 223 V (22KΩ)
R147	7030003560	S.RESISTOR ERJ3GEYJ 103 V (10KΩ)
R148	7030003440	S.RESISTOR ERJ3GEYJ 102 V (1KΩ)
R149	7030003620	S.RESISTOR ERJ3GEYJ 333 V (33KΩ)
R150	7030003560	S.RESISTOR ERJ3GEYJ 103 V (10KΩ)
R151	7030003620	S.RESISTOR ERJ3GEYJ 333 V (33KΩ)
R152	7030003560	S.RESISTOR ERJ3GEYJ 103 V (10KΩ)
R153	7030003620	S.RESISTOR ERJ3GEYJ 333 V (33KΩ)
R154	7030003560	S.RESISTOR ERJ3GEYJ 103 V (10KΩ)
R155	7030003550	S.RESISTOR ERJ3GEYJ 822 V (8.2KΩ)
R156	7030003320	S.RESISTOR ERJ3GEYJ 101 V (100Ω)
R157	7030003790	S.RESISTOR ERJ3GEYJ 824 V (820KΩ)
R158	7030003570	S.RESISTOR ERJ3GEYJ 123 V (12KΩ)
R159	7030003320	S.RESISTOR ERJ3GEYJ 101 V (100Ω)
R160	7030000100	S.RESISTOR MCR10EZJH 4.7 Ω (4R7)
R161	7030000100	S.RESISTOR MCR10EZJH 4.7 Ω (4R7)
R162	7030003680	S.RESISTOR ERJ3GEYJ 104 V (100KΩ)
R163	7030003440	S.RESISTOR ERJ3GEYJ 102 V (1KΩ)

[MAIN-A UNIT]

REF. NO.	PARTS NO.	DESCRIPTION
C1	4550002950	S.TANTALUM TESVA 0J 335M1-8L
C2	4030006860	S.CERAMIC C1608 JB 1H 102K-T-A
C3	4030006860	S.CERAMIC C1608 JB 1H 102K-T-A
C4	4030008680	S.CERAMIC C2012 JF 1C 105Z-T-A
C5	4510003150	ELECTROL 35 SS 33μF
C6	4030006860	S.CERAMIC C1608 JB 1H 102K-T-A
C7	4030006860	S.CERAMIC C1608 JB 1H 102K-T-A
C8	4510002640	ELECTROL 25 SS 47μF
C9	4030006860	S.CERAMIC C1608 JB 1H 102K-T-A
C10	4030006860	S.CERAMIC C1608 JB 1H 102K-T-A
C11	4030006860	S.CERAMIC C1608 JB 1H 102K-T-A
C12	4030006860	S.CERAMIC C1608 JB 1H 102K-T-A
C13	4030006570	S.CERAMIC C1608 SL 1H 060D-T-A
C14	4030006860	S.CERAMIC C1608 JB 1H 102K-T-A
C15	4030006860	S.CERAMIC C1608 JB 1H 102K-T-A
C16	4030006860	S.CERAMIC C1608 JB 1H 102K-T-A
C17	4030006850	S.CERAMIC C1608 JB 1H 471K-T-A
C18	4030006570	S.CERAMIC C1608 SL 1H 060D-T-A
C19	4030006610	S.CERAMIC C1608 SL 1H 100D-T-A
C20	4030006660	S.CERAMIC C1608 SL 1H 220J-T-A
C21	4030006610	S.CERAMIC C1608 SL 1H 100D-T-A
C22	4030006860	S.CERAMIC C1608 JB 1H 102K-T-A
C23	4030006580	S.CERAMIC C1608 SL 1H 070D-T-A
C24	4030006860	S.CERAMIC C1608 JB 1H 102K-T-A
C25	4030006660	S.CERAMIC C1608 SL 1H 220J-T-A
C26	4030006860	S.CERAMIC C1608 JB 1H 102K-T-A
C27	4030006860	S.CERAMIC C1608 JB 1H 102K-T-A
C28	4030006860	S.CERAMIC C1608 JB 1H 102K-T-A
C29	4030006660	S.CERAMIC C1608 SL 1H 220J-T-A
C30	4030006660	S.CERAMIC C1608 SL 1H 220J-T-A
C31	4030006860	S.CERAMIC C1608 JB 1H 102K-T-A
C32	4030006610	S.CERAMIC C1608 SL 1H 100D-T-A
C33	4030006860	S.CERAMIC C1608 JB 1H 102K-T-A
C34	4030006660	S.CERAMIC C1608 SL 1H 220J-T-A
C35	4030006860	S.CERAMIC C1608 JB 1H 102K-T-A
C36	4550000260	TANTALUM DN 1V 100M
C37	4030006860	S.CERAMIC C1608 JB 1H 102K-T-A
C38	4030006860	S.CERAMIC C1608 JB 1H 102K-T-A
C39	4030006860	S.CERAMIC C1608 JB 1H 102K-T-A
C40	4030006860	S.CERAMIC C1608 JB 1H 102K-T-A
C41	4030006860	S.CERAMIC C1608 JB 1H 102K-T-A
C42	4010003880	CERAMIC DD06 SL 150K 500V
C43	4030006860	S.CERAMIC C1608 JB 1H 102K-T-A
C44	4030006860	S.CERAMIC C1608 JB 1H 102K-T-A
C45	4030006860	S.CERAMIC C1608 JB 1H 102K-T-A
C46	4030006860	S.CERAMIC C1608 JB 1H 102K-T-A
C47	4010003880	CERAMIC DD06 SL 150K 500V
C48	4030006860	S.CERAMIC C1608 JB 1H 102K-T-A
C49	4030006860	S.CERAMIC C1608 JB 1H 102K-T-A
C50	4010004110	CERAMIC DD05 B 471K 500V
C51	4510001350	ELECTROL 16 MS5 10μF
C52	4030006860	S.CERAMIC C1608 JB 1H 102K-T-A
C53	4030006860	S.CERAMIC C1608 JB 1H 102K-T-A
C54	4030006860	S.CERAMIC C1608 JB 1H 102K-T-A
C55	4010004120	CERAMIC DD07 B 102K 500V
C56	4010003890	CERAMIC DD06 SL 180K 500V
C57	4030006860	S.CERAMIC C1608 JB 1H 102K-T-A
C58	4010003930	CERAMIC DD06 SL 270K 500V
C59	4010003930	CERAMIC DD06 SL 270K 500V
C60	4030006860	S.CERAMIC C1608 JB 1H 102K-T-A
C61	4030006860	S.CERAMIC C1608 JB 1H 102K-T-A
C62	4010003890	CERAMIC DD06 SL 180K 500V
C63	4030006700	S.CERAMIC C1608 SL 1H 390J-T-A
C64	4030006660	S.CERAMIC C1608 SL 1H 220J-T-A
C65	4030006860	S.CERAMIC C1608 JB 1H 102K-T-A
C66	4030006860	S.CERAMIC C1608 JB 1H 102K-T-A
C67	4030008630	S.CERAMIC C1608 JF 1C 104Z-T-A
C68	4030006760	S.CERAMIC C1608 SL 1H 121J-T-A
C69	4030008630	S.CERAMIC C1608 JF 1C 104Z-T-A
C70	4030006710	S.CERAMIC C1608 SL 1H 470J-T-A
C71	4030006660	S.CERAMIC C1608 SL 1H 220J-T-A

S. = Surface mount

[MAIN-A UNIT]

REF. NO.	PARTS NO.	DESCRIPTION
C72	4030008630	S.CERAMIC C1608 JF 1C 104Z-T-A
C73	4030008680	S.CERAMIC C2012 JF 1C 105Z-T-A
C74	4030006860	S.CERAMIC C1608 JB 1H 102K-T-A
C75	4030006860	S.CERAMIC C1608 JB 1H 102K-T-A
C76	4030006860	S.CERAMIC C1608 JB 1H 102K-T-A
C77	4030008630	S.CERAMIC C1608 JF 1C 104Z-T-A
C78	4510002640	ELECTROL 25 SS 47μF
C79	4030006860	S.CERAMIC C1608 JB 1H 102K-T-A
C80	4030006860	S.CERAMIC C1608 JB 1H 102K-T-A
C81	4030006890	S.CERAMIC C1608 JF 1H 103Z-T-A
C82	4030006690	S.CERAMIC C1608 SL 1H 330J-T-A
C83	4030006860	S.CERAMIC C1608 JB 1H 102K-T-A
C84	4030006860	S.CERAMIC C1608 JB 1H 102K-T-A
C85	4030006900	S.CERAMIC C1608 JB 1E 103K-T-A
C86	4030006900	S.CERAMIC C1608 JB 1E 103K-T-A
C87	4510002930	ELECTROL 50 SS R47μF
C88	4030006660	S.CERAMIC C1608 SL 1H 220J-T-A
C89	4030006730	S.CERAMIC C1608 SL 1H 680J-T-A
C90	4030008630	S.CERAMIC C1608 JF 1C 104Z-T-A
C91	4030006540	S.CERAMIC C1608 SL 1H 030C-T-A
C92	4030006860	S.CERAMIC C1608 JB 1H 102K-T-A
C93	4030008630	S.CERAMIC C1608 JF 1C 104Z-T-A
C94	4030006900	S.CERAMIC C1608 JB 1E 103K-T-A
C95	4030006730	S.CERAMIC C1608 SL 1H 680J-T-A
C96	4030006740	S.CERAMIC C1608 SL 1H 820J-T-A
C97	4030006900	S.CERAMIC C1608 JB 1E 103K-T-A
C98	4030006860	S.CERAMIC C1608 JB 1H 102K-T-A
C99	4030006590	S.CERAMIC C1608 SL 1H 080D-T-A
C100	4030006630	S.CERAMIC C1608 SL 1H 150J-T-A
C101	4030006510	S.CERAMIC C1608 SL 1H 0R5C-T-A
C102	4030006850	S.CERAMIC C1608 JB 1H 471K-T-A
C103	4030006610	S.CERAMIC C1608 SL 1H 100D-T-A
C104	4030006630	S.CERAMIC C1608 SL 1H 150J-T-A
C105	4030006520	S.CERAMIC C1608 SL 1H 010C-T-A
C106	4030006510	S.CERAMIC C1608 SL 1H 0R5C-T-A
C107	4030006600	S.CERAMIC C1608 SL 1H 090D-T-A
C108	4030006860	S.CERAMIC C1608 JB 1H 102K-T-A
C109	4030006540	S.CERAMIC C1608 SL 1H 030C-T-A
C110	4030006860	S.CERAMIC C1608 JB 1H 102K-T-A
C111	4030006860	S.CERAMIC C1608 JB 1H 102K-T-A
C112	4030006630	S.CERAMIC C1608 SL 1H 150J-T-A
C113	4030006860	S.CERAMIC C1608 JB 1H 102K-T-A
C114	4030006860	S.CERAMIC C1608 JB 1H 102K-T-A
C115	4030006690	S.CERAMIC C1608 SL 1H 330J-T-A
C116	4030006860	S.CERAMIC C1608 JB 1H 102K-T-A
C117	4030006640	S.CERAMIC C1608 SL 1H 180J-T-A
C118	4030006860	S.CERAMIC C1608 JB 1H 102K-T-A
C119	4030006750	S.CERAMIC C1608 SL 1H 101J-T-A
C120	4030006670	S.CERAMIC C1608 SL 1H 270J-T-A
C121	4030006590	S.CERAMIC C1608 SL 1H 080D-T-A
C122	4030008630	S.CERAMIC C1608 JF 1C 104Z-T-A
C123	4030008680	S.CERAMIC C2012 JF 1C 105Z-T-A
C124	4030008630	S.CERAMIC C1608 JF 1C 104Z-T-A
C125	4030008680	S.CERAMIC C2012 JF 1C 105Z-T-A
C126	4030006860	S.CERAMIC C1608 JB 1H 102K-T-A
C127	4030008630	S.CERAMIC C1608 JF 1C 104Z-T-A
C128	4030006860	S.CERAMIC C1608 JB 1H 102K-T-A
C129	4030006860	S.CERAMIC C1608 JB 1H 102K-T-A
C130	4030006860	S.CERAMIC C1608 JB 1H 102K-T-A
C131	4030006860	S.CERAMIC C1608 JB 1H 102K-T-A
C133	4030008680	S.CERAMIC C2012 JF 1C 105Z-T-A
C135	4030008670	S.CERAMIC C2012 JB 1H 562K-T-A
C136	4030008670	S.CERAMIC C2012 JB 1H 562K-T-A
C137	4030006470	S.CERAMIC C2012 JB 1H 153K-T-A
C138	4030008660	S.CERAMIC C2012 JB 1H 333K-T-A
C139	4030008630	S.CERAMIC C1608 JF 1C 104Z-T-A
C140	4030008630	S.CERAMIC C1608 JF 1C 104Z-T-A
C141	4030006470	S.CERAMIC C2012 JB 1H 153K-T-A
C142	4030006900	S.CERAMIC C1608 JB 1E 103K-T-A
C143	4030006900	S.CERAMIC C1608 JB 1E 103K-T-A
C144	4030008630	S.CERAMIC C1608 JF 1C 104Z-T-A
C145	4030008680	S.CERAMIC C2012 JF 1C 105Z-T-A

[MAIN-A UNIT]

REF. NO.	PARTS NO.	DESCRIPTION
C146	4030008630	S.CERAMIC C1608 JF 1C 104Z-T-A
C147	4030008670	S.CERAMIC C2012 JB 1H 562K-T-A
C148	4030008670	S.CERAMIC C2012 JB 1H 562K-T-A
C149	4030006470	S.CERAMIC C2012 JB 1H 153K-T-A
C150	4030008660	S.CERAMIC C2012 JB 1H 333K-T-A
C151	4030008630	S.CERAMIC C1608 JF 1C 104Z-T-A
C152	4030008630	S.CERAMIC C1608 JF 1C 104Z-T-A
C153	4030006470	S.CERAMIC C2012 JB 1H 153K-T-A
C154	4030006900	S.CERAMIC C1608 JB 1E 103K-T-A
C155	4030006900	S.CERAMIC C1608 JB 1E 103K-T-A
C156	4550000270	S.TANTALUM TESVA 1E 474M1-8L
C157	4550000270	S.TANTALUM TESVA 1E 474M1-8L
C158	4030008630	S.CERAMIC C1608 JF 1C 104Z-T-A
C159	4550002890	S.TANTALUM TESVA 1A 225M1-8L
C160	4030006750	S.CERAMIC C1608 SL 1H 101J-T-A
C161	4030006750	S.CERAMIC C1608 SL 1H 101J-T-A
C162	4030006750	S.CERAMIC C1608 SL 1H 101J-T-A
C163	4030006750	S.CERAMIC C1608 SL 1H 101J-T-A
C164	4030006750	S.CERAMIC C1608 SL 1H 101J-T-A
C165	4030006750	S.CERAMIC C1608 SL 1H 101J-T-A
C166	4030006750	S.CERAMIC C1608 SL 1H 101J-T-A
C167	4030006750	S.CERAMIC C1608 SL 1H 101J-T-A
C168	4030006750	S.CERAMIC C1608 SL 1H 101J-T-A
C169	4030006750	S.CERAMIC C1608 SL 1H 101J-T-A
C170	4030006750	S.CERAMIC C1608 SL 1H 101J-T-A
C171	4030006750	S.CERAMIC C1608 SL 1H 101J-T-A
C172	4030006750	S.CERAMIC C1608 SL 1H 101J-T-A
C173	4030006750	S.CERAMIC C1608 SL 1H 101J-T-A
C174	4030006750	S.CERAMIC C1608 SL 1H 101J-T-A
C175	4030006750	S.CERAMIC C1608 SL 1H 101J-T-A
C176	4030006750	S.CERAMIC C1608 SL 1H 101J-T-A
C177	4510002380	ELECTROL 16 SS 470μF (10X12.5)
C178	4510002640	ELECTROL 25 SS 47μF
C179	4510002440	ELECTROL 16 SS 220μF (8X11)
C180	4510002640	ELECTROL 25 SS 47μF
C181	4510002730	ELECTROL 10 SS 100μF
C182	4510002760	ELECTROL 10 SS 470μF
C183	4510001720	ELECTROL 16 SS 330μF (8X12.5)
C184	4510002730	ELECTROL 10 SS 100μF
C185	4510002760	ELECTROL 10 SS 470μF
C186	4030008760	S.CERAMIC C2012 X7R 1C 104K-T-A
C187	4030008760	S.CERAMIC C2012 X7R 1C 104K-T-A
C188	4030006860	S.CERAMIC C1608 JB 1H 102K-T-A
C189	4030008680	S.CERAMIC C2012 JF 1C 105Z-T-A
C190	4030008630	S.CERAMIC C1608 JF 1C 104Z-T-A
C191	4030006860	S.CERAMIC C1608 JB 1H 102K-T-A
C192	4030006870	S.CERAMIC C1608 JB 1H 222K-T-A
C193	4550000280	S.TANTALUM TESVB2 1A 475M-8L
C194	4030006850	S.CERAMIC C1608 JB 1H 471K-T-A
C195	4030006850	S.CERAMIC C1608 JB 1H 471K-T-A
C196	4030006850	S.CERAMIC C1608 JB 1H 471K-T-A
C197	4030006850	S.CERAMIC C1608 JB 1H 471K-T-A
C198	4030006850	S.CERAMIC C1608 JB 1H 471K-T-A
C199	4030006850	S.CERAMIC C1608 JB 1H 471K-T-A
EP1	910033532	PCB B 3287B

[VCO-A UNIT]

REF. NO.	PARTS NO.	DESCRIPTION
IC1	1130004200	S.IC TC4S66F (TE85R)
IC2	1130005700	S.IC M56760FP
Q1	1590000480	S.TRANSISTOR RN2402 (TE85R)
Q2	1530000160	S.TRANSISTOR 2SC2712-Y (TE85RTEM)
Q3	1560000360	S.FET 2SK209-Y (TE85R)
Q4	1530002490	S.TRANSISTOR 2SC3324-GR (TE85R)

S. = Surface mount

[VCO-A UNIT]

REF. NO.	PARTS NO.	DESCRIPTION	
Q5	1560000640	S.FET	2SK1740-TA
Q6	1530002240	S.TRANSISTOR	2SC3775-3-TA
D1	1720000220	S.VARICAP	1SV166-T2B
D2	1720000220	S.VARICAP	1SV166-T2B
L1	6200001580	S.COIL	LER 015T 1R8M
L2	6200001580	S.COIL	LER 015T 1R8M
L3	6200001580	S.COIL	LER 015T 1R8M
L4	6130002420	S.COIL	LB-270
L5	6200001230	S.COIL	MLF2012A 1R0M-T
R1	7030003480	S.RESISTOR	ERJ3GEYJ 222 V (2.2K Ω)
R2	7030003530	S.RESISTOR	ERJ3GEYJ 562 V (5.6K Ω)
R3	7030003640	S.RESISTOR	ERJ3GEYJ 473 V (47K Ω)
R4	7030003560	S.RESISTOR	ERJ3GEYJ 103 V (10K Ω)
R5	7030003520	S.RESISTOR	ERJ3GEYJ 472 V (4.7K Ω)
R6	7030003640	S.RESISTOR	ERJ3GEYJ 473 V (47K Ω)
R7	7030003320	S.RESISTOR	ERJ3GEYJ 101 V (100 Ω)
R8	7030003530	S.RESISTOR	ERJ3GEYJ 562 V (5.6K Ω)
R9	7030003450	S.RESISTOR	ERJ3GEYJ 122 V (1.2K Ω)
R10	7030003410	S.RESISTOR	ERJ3GEYJ 561 V (560 Ω)
R11	7030000460	S.RESISTOR	MCR10EZJH 4.7K Ω (472)
R12	7030003530	S.RESISTOR	ERJ3GEYJ 562 V (5.6K Ω)
R13	7030003360	S.RESISTOR	ERJ3GEYJ 221 V (220 Ω)
R14	7030003320	S.RESISTOR	ERJ3GEYJ 101 V (100 Ω)
R15	7030003400	S.RESISTOR	ERJ3GEYJ 471 V (470 Ω)
R16	7030003670	S.RESISTOR	ERJ3GEYJ 823 V (82K Ω)
R17	7030003320	S.RESISTOR	ERJ3GEYJ 101 V (100 Ω)
R18	7030003280	S.RESISTOR	ERJ3GEYJ 470 V (47 Ω)
R19	7030003600	S.RESISTOR	ERJ3GEYJ 223 V (22K Ω)
R20	7030003400	S.RESISTOR	ERJ3GEYJ 471 V (470 Ω)
R21	7030003480	S.RESISTOR	ERJ3GEYJ 222 V (2.2K Ω)
R22	7030003520	S.RESISTOR	ERJ3GEYJ 472 V (4.7K Ω)
R23	7030003220	S.RESISTOR	ERJ3GEYJ 150 V (15 Ω)
R24	7030003400	S.RESISTOR	ERJ3GEYJ 471 V (470 Ω)
R25	7030003220	S.RESISTOR	ERJ3GEYJ 150 V (15 Ω)
R26	7030003320	S.RESISTOR	ERJ3GEYJ 101 V (100 Ω)
C1	4030006850	S.CERAMIC	C1608 JB 1H 471K-T-A
C2	4030008680	S.CERAMIC	C2012 JF 1C 105Z-T-A
C3	4030004750	S.CERAMIC	C2012 JB 1H 103K-T-A
C4	4030008680	S.CERAMIC	C2012 JF 1C 105Z-T-A
C5	4030006900	S.CERAMIC	C1608 JB 1E 103K-T-A
C6	4550000940	S.TANTALUM	TESVB2 1D 225M-8L
C7	4550000940	S.TANTALUM	TESVB2 1D 225M-8L
C8	4030006900	S.CERAMIC	C1608 JB 1E 103K-T-A
C9	4550000550	S.TANTALUM	TESVA 1V 224M1-8L
C10	4030008630	S.CERAMIC	C1608 JF 1C 104Z-T-A
C11	4030006890	S.CERAMIC	C1608 JF 1H 103Z-T-A
C12	4030006860	S.CERAMIC	C1608 JB 1H 102K-T-A
C13	4030006860	S.CERAMIC	C1608 JB 1H 102K-T-A
C14	4030006860	S.CERAMIC	C1608 JB 1H 102K-T-A
C15	4030006900	S.CERAMIC	C1608 JB 1E 103K-T-A
C16	4030006860	S.CERAMIC	C1608 JB 1H 102K-T-A
C17	4030006860	S.CERAMIC	C1608 JB 1H 102K-T-A
C18	4030006860	S.CERAMIC	C1608 JB 1H 102K-T-A
C19	4030006920	S.CERAMIC	C1608 CH 1H 010C-T-A
C20	4030006860	S.CERAMIC	C1608 JB 1H 102K-T-A
C21	4030006850	S.CERAMIC	C1608 JB 1H 471K-T-A
C22	4030007010	S.CERAMIC	C1608 CH 1H 100D-T-A
C23	4030006900	S.CERAMIC	C1608 JB 1E 103K-T-A
C24	4030007010	S.CERAMIC	C1608 CH 1H 100D-T-A
C25	4030006860	S.CERAMIC	C1608 JB 1H 102K-T-A
EP1	910032833	PCB	B 3289C

[MAIN-B UNIT]

REF. NO.	PARTS NO.	DESCRIPTION	
IC1	1130004200	S.IC	TC4S66F (TE85R)
IC2	1150000180	IC	SC1027 (IC-3230A/E)
	1150000750	IC	SC1054 (IC-3230H)
IC3	1110001240	S.IC	μ PC358G2-T1
IC4	1110002200	S.IC	MC3372MR
IC5	1130005810	S.IC	BU4094BF-T1
IC6	1110001971	S.IC	μ PC1676G-T1
IC7	1110002020	IC	TA7805S
IC8	1110001700	S.IC	TL499ACPS
IC9	1110000490	IC	AN6541
Q1	1510000580	S.TRANSISTOR	2SA1362-GR (TE85R)
Q2	1530000160	S.TRANSISTOR	2SC2712-Y (TE85RTEM)
Q3	1530000160	S.TRANSISTOR	2SC2712-Y (TE85RTEM)
Q4	1530002360	S.TRANSISTOR	2SC2714-Y (TE85R)
Q5	1530002050	S.TRANSISTOR	2SC3661-TA
Q6	1530002240	S.TRANSISTOR	2SC3775-3-TA
Q7	1530002240	S.TRANSISTOR	2SC3775-3-TA
Q8	1590000390	TRANSISTOR	MRF-559
Q9	1590000420	S.TRANSISTOR	RN1404 (TE85R)
Q10	1590000420	S.TRANSISTOR	RN1404 (TE85R)
Q11	1520000380	TRANSISTOR	2SB1143 S
Q12	1530000160	S.TRANSISTOR	2SC2712-Y (TE85RTEM)
Q13	1530002020	S.TRANSISTOR	2SC3770-3-TA
Q14	1530000160	S.TRANSISTOR	2SC2712-Y (TE85RTEM)
Q15	1590000420	S.TRANSISTOR	RN1404 (TE85R)
Q16	1580000350	S.FET	3SK140-Y (TE85R)
Q17	1530002240	S.TRANSISTOR	2SC3775-3-TA
Q18	1580000360	S.FET	3SK177-T2B U73
Q19	1590000690	S.TRANSISTOR	IMD6 T108
Q20	1590000460	S.TRANSISTOR	RN1402 (TE85R)
Q21	1590000460	S.TRANSISTOR	RN1402 (TE85R)
Q22	1590000460	S.TRANSISTOR	RN1402 (TE85R)
Q23	1590000980	S.TRANSISTOR	DTB123EK T147
Q24	1590000980	S.TRANSISTOR	DTB123EK T147
Q25	1590000980	S.TRANSISTOR	DTB123EK T147
Q26	1520000230	TRANSISTOR	2SB909M Q
Q27	1530000160	S.TRANSISTOR	2SC2712-Y (TE85RTEM)
Q28	1530001940	S.TRANSISTOR	2SC2712-BL (TE85R)
Q29	1540000150	TRANSISTOR	2SD1225M R
Q30	1590001000	S.TRANSISTOR	RN2427 (TE85R)
Q31	1510000700	S.TRANSISTOR	2SA1736 (TE12R)
D1	1730001120	S.ZENER	RD24M-T2B2
D2	1750000060	S.DIODE	1SS196 (TE85R)
D4	1750000080	S.DIODE	1SS153-T2
D5	1790000450	S.DIODE	MA862(TX)
D6	1750000060	S.DIODE	1SS196 (TE85R)
D7	1790000490	S.DIODE	HSM88AS-TR
D8	1790000490	S.DIODE	HSM88AS-TR
D9	1710000290	DIODE	MI308 (IC-3230A/E)
D9	1710000310	DIODE	MI407 (IC-3230H)
D10	1730000730	S.ZENER	RD6.2M-T2B2
D11	1790000490	S.DIODE	HSM88AS-TR
D12	1750000070	S.DIODE	1SS226 (TE85R)
D13	1790000450	S.DIODE	MA862(TX)
D14	1790000450	S.DIODE	MA862(TX)
D15	1750000070	S.DIODE	1SS226 (TE85R)
D16	1710000290	DIODE	MI308
D17	1710000290	DIODE	MI308
D18	1750000020	S.DIODE	1SS184 (TE85R)
D20	1750000020	S.DIODE	1SS184 (TE85R)
D21	1750000020	S.DIODE	1SS184 (TE85R)
D22	1750000060	S.DIODE	1SS196 (TE85R)
D23	1730000640	S.ZENER	RD4.3M-T2B1 (IC-3230A/E)
	1730000650	S.ZENER	RD4.3M-T2B2 (IC-3230H)
D24	1750000060	S.DIODE	1SS196 (TE85R)
D25	1750000060	S.DIODE	1SS196 (TE85R)
D27	1790000700	DIODE	DSA3A1

S. = Surface mount

[MAIN-B UNIT]

REF. NO.	PARTS NO.	DESCRIPTION	
D28	1750000060	S.DIODE	1SS196 (TE85R)
X1	6050006950	XTAL	CR-323
X2	6070000080	DISCRI	CDBM455C16
X3	6050007470	XTAL	CR-342
FI1	2020000550	CERAMIC	CFUM455E
FI2	2010001220	FILTER	30M15B9 (FL-150)
L1	6200000110	S.COIL	LQN 2A 33NM
L2	6200000090	S.COIL	LQN 2A 18NM
L3	6200000110	S.COIL	LQN 2A 33NM
L4	6200000720	S.COIL	LQN 2A 10NM
L5	6200000110	S.COIL	LQN 2A 33NM
L6	6200000090	S.COIL	LQN 2A 18NM
L7	6110001520	COIL	LA-232
L8	6170000180	COIL	LW-19
L9	6110002110	COIL	LA-382
L10	6110001520	COIL	LA-232
L11	6110001590	COIL	LA-242
L12	6110001520	COIL	LA-232
L13	6180001210	COIL	LAL 03NA 8R2K
L14	6150003220	COIL	LS-320
L15	6150002000	COIL	LS-264
L16	6200000090	S.COIL	LQN 2A 18NM
L17	6200000100	S.COIL	LQN 2A 22NM
L18	6150003240	COIL	LS-338 (HR5W)
L19	6150003230	COIL	LS-337 (HR5W)
L20	6200000720	S.COIL	LQN 2A 10NM
L21	6200000720	S.COIL	LQN 2A 10NM
L22	6110002110	COIL	LA-382
L23	6110001520	COIL	LA-232
L24	6200000090	S.COIL	LQN 2A 18NM
L25	6200000090	S.COIL	LQN 2A 18NM
L26	6180002620	COIL	RCR664D-101K
L27	6180001120	COIL	FL 5H 101K
R1	7030003480	S.RESISTOR	ERJ3GEYJ 222 V (2.2K Ω)
R2	7030003480	S.RESISTOR	ERJ3GEYJ 222 V (2.2K Ω)
R3	7030003640	S.RESISTOR	ERJ3GEYJ 473 V (47K Ω)
R4	7030003540	S.RESISTOR	ERJ3GEYJ 682 V (6.8K Ω)
R5	7030003680	S.RESISTOR	ERJ3GEYJ 104 V (100K Ω)
R6	4610001110	TRIMMER	EVM-LGGA00 B15 (104)
R7	7030003600	S.RESISTOR	ERJ3GEYJ 223 V (22K Ω)
R8	7030003680	S.RESISTOR	ERJ3GEYJ 104 V (100K Ω)
R9	7030003320	S.RESISTOR	ERJ3GEYJ 101 V (100 Ω)
R10	7030003480	S.RESISTOR	ERJ3GEYJ 222 V (2.2K Ω)
R11	7030003740	S.RESISTOR	ERJ3GEYJ 334 V (330K Ω)
R12	7030003480	S.RESISTOR	ERJ3GEYJ 222 V (2.2K Ω)
R13	7030003200	S.RESISTOR	ERJ3GEYJ 100 V (10 Ω)
R14	7030003380	S.RESISTOR	ERJ3GEYJ 331 V (330 Ω)
R15	7030003380	S.RESISTOR	ERJ3GEYJ 331 V (330 Ω)
R16	7030003460	S.RESISTOR	ERJ3GEYJ 152 V (1.5K Ω)
R17	7030003520	S.RESISTOR	ERJ3GEYJ 472 V (4.7K Ω)
R18	7030003280	S.RESISTOR	ERJ3GEYJ 470 V (47 Ω)
R19	7030003440	S.RESISTOR	ERJ3GEYJ 102 V (1K Ω)
R20	7030003360	S.RESISTOR	ERJ3GEYJ 221 V (220 Ω)
R21	7030000260	S.RESISTOR	MCR10EZHJ 100 Ω (101)
R22	7030003480	S.RESISTOR	ERJ3GEYJ 222 V (2.2K Ω)
R23	7030003480	S.RESISTOR	ERJ3GEYJ 222 V (2.2K Ω)
R24	7030003370	S.RESISTOR	ERJ3GEYJ 271 V (270 Ω)
R25	7030003230	S.RESISTOR	ERJ3GEYJ 180 V (18 Ω)
R26	7030003370	S.RESISTOR	ERJ3GEYJ 271 V (270 Ω)
R27	7030003400	S.RESISTOR	ERJ3GEYJ 471 V (470 Ω)
R28	7030003520	S.RESISTOR	ERJ3GEYJ 472 V (4.7K Ω)
R29	7030003450	S.RESISTOR	ERJ3GEYJ 122 V (1.2K Ω)
R30	7030003560	S.RESISTOR	ERJ3GEYJ 103 V (10K Ω)

[MAIN-B UNIT]

REF. NO.	PARTS NO.	DESCRIPTION	
R31	7030003320	S.RESISTOR	ERJ3GEYJ 101 V (100 Ω)
R32	7030003440	S.RESISTOR	ERJ3GEYJ 102 V (1K Ω) (IC-3230A/E)
	7030003600	S.RESISTOR	ERJ3GEYJ 223 V (22K Ω) (IC-3230H)
R33	7030003340	S.RESISTOR	ERJ3GEYJ 151 V (150 Ω) (IC-3230A/E)
	7030003520	S.RESISTOR	ERJ3GEYJ 472 V (4.7K Ω) (IC-3230H)
R34	7030003440	S.RESISTOR	ERJ3GEYJ 102 V (1K Ω)
R35	7030003440	S.RESISTOR	ERJ3GEYJ 102 V (1K Ω) (IC-3230A/E)
	7030003540	S.RESISTOR	ERJ3GEYJ 682 V (6.8K Ω) (IC-3230H)
R36	4610001100	TRIMMER	EVM-LGGA00 B34 (303)
R37	7030003460	S.RESISTOR	ERJ3GEYJ 152 V (1.5K Ω) (IC-3230A/E)
	7030003500	S.RESISTOR	ERJ3GEYJ 332 V (3.3K Ω) (IC-3230H)
R38	7030003570	S.RESISTOR	ERJ3GEYJ 123 V (12K Ω) (IC-3230A/E)
	7030003540	S.RESISTOR	ERJ3GEYJ 682 V (6.8K Ω) (IC-3230H)
R39	7030001050	S.RESISTOR	MCR50JZHJ 22 Ω (220)
R40	7030001180	S.RESISTOR	MCR50JZHJ 270 Ω (271)
R41	7010004130	RESISTOR	R20J 330 Ω
R42	7030000400	S.RESISTOR	MCR10EZHJ 1.5K Ω (152) (IC-3230A/E)
	7030000480	S.RESISTOR	MCR10EZHJ 6.8K Ω (682) (IC-3230H)
R43	7030000270	S.RESISTOR	MCR10EZHJ 120 Ω (121) (IC-3230A/E)
	7030000250	S.RESISTOR	MCR10EZHJ 82 Ω (820) (IC-3230H)
R44	7030003560	S.RESISTOR	ERJ3GEYJ 103 V (10K Ω)
R45	7030003640	S.RESISTOR	ERJ3GEYJ 473 V (47K Ω)
R46	7030003560	S.RESISTOR	ERJ3GEYJ 103 V (10K Ω)
R47	7010004720	RESISTOR	R50XJ 100 Ω
R48	7030000400	S.RESISTOR	MCR10EZHJ 1.5K Ω (152) (IC-3230A/E)
	7030000460	S.RESISTOR	MCR10EZHJ 4.7K Ω (472) (IC-3230H)
R49	7030000270	S.RESISTOR	MCR10EZHJ 120 Ω (121)
R50	7030003790	S.RESISTOR	ERJ3GEYJ 824 V (820K Ω)
R51	7030003580	S.RESISTOR	ERJ3GEYJ 153 V (15K Ω) (IC-3230A/E)
	7030003560	S.RESISTOR	ERJ3GEYJ 103 V (10K Ω) (IC-3230H)
R52	7030003320	S.RESISTOR	ERJ3GEYJ 101 V (100 Ω)
R53	7030003600	S.RESISTOR	ERJ3GEYJ 223 V (22K Ω)
R54	7030003640	S.RESISTOR	ERJ3GEYJ 473 V (47K Ω)
R55	7030003570	S.RESISTOR	ERJ3GEYJ 123 V (12K Ω)
R56	7030003720	S.RESISTOR	ERJ3GEYJ 224 V (220K Ω)
R57	7030003640	S.RESISTOR	ERJ3GEYJ 473 V (47K Ω)
R58	7030003640	S.RESISTOR	ERJ3GEYJ 473 V (47K Ω)
R59	7030000250	S.RESISTOR	MCR10EZHJ 82 Ω (820)
R60	7030003520	S.RESISTOR	ERJ3GEYJ 472 V (4.7K Ω)
R61	7030003470	S.RESISTOR	ERJ3GEYJ 182 V (1.8K Ω)
R62	7030003640	S.RESISTOR	ERJ3GEYJ 473 V (47K Ω)
R63	7030003520	S.RESISTOR	ERJ3GEYJ 472 V (4.7K Ω)
R64	7030003450	S.RESISTOR	ERJ3GEYJ 122 V (1.2K Ω)
R65	7030003440	S.RESISTOR	ERJ3GEYJ 102 V (1K Ω)
R66	7030003400	S.RESISTOR	ERJ3GEYJ 471 V (470 Ω)
R67	7030003480	S.RESISTOR	ERJ3GEYJ 222 V (2.2K Ω)
R68	7030003340	S.RESISTOR	ERJ3GEYJ 151 V (150 Ω)
R69	7030003760	S.RESISTOR	ERJ3GEYJ 474 V (470K Ω)
R70	7030003520	S.RESISTOR	ERJ3GEYJ 472 V (4.7K Ω)
R71	7030003680	S.RESISTOR	ERJ3GEYJ 104 V (100K Ω)
R72	7030003680	S.RESISTOR	ERJ3GEYJ 104 V (100K Ω)
R73	7030003400	S.RESISTOR	ERJ3GEYJ 471 V (470 Ω)
R74	7030003600	S.RESISTOR	ERJ3GEYJ 223 V (22K Ω)

S. = Surface mount

[MAIN-B UNIT]

REF. NO.	PARTS NO.	DESCRIPTION
R75	7030003520	S.RESISTOR ERJ3GEYJ 472 V (4.7KΩ)
R76	7030003320	S.RESISTOR ERJ3GEYJ 101 V (100Ω)
R77	4610001110	TRIMMER EVM-LGGA00 B15 (104)
R78	7030003320	S.RESISTOR ERJ3GEYJ 101 V (100Ω)
R79	7030003200	S.RESISTOR ERJ3GEYJ 100 V (10Ω)
R80	7030003320	S.RESISTOR ERJ3GEYJ 101 V (100Ω)
R81	7030003480	S.RESISTOR ERJ3GEYJ 222 V (2.2KΩ)
R82	7030003350	S.RESISTOR ERJ3GEYJ 181 V (180Ω)
R83	7030003350	S.RESISTOR ERJ3GEYJ 181 V (180Ω)
R84	7030003260	S.RESISTOR ERJ3GEYJ 330 V (33Ω)
R85	7030003300	S.RESISTOR ERJ3GEYJ 680 V (68Ω)
R86	7030003480	S.RESISTOR ERJ3GEYJ 222 V (2.2KΩ)
R87	7030003560	S.RESISTOR ERJ3GEYJ 103 V (10KΩ)
R88	7030003440	S.RESISTOR ERJ3GEYJ 102 V (1KΩ)
R89	7030003520	S.RESISTOR ERJ3GEYJ 472 V (4.7KΩ)
R90	7030003380	S.RESISTOR ERJ3GEYJ 331 V (330Ω)
R91	7030003440	S.RESISTOR ERJ3GEYJ 102 V (1KΩ)
R92	7030003320	S.RESISTOR ERJ3GEYJ 101 V (100Ω)
R93	7030003580	S.RESISTOR ERJ3GEYJ 153 V (15KΩ)
R94	7030003280	S.RESISTOR ERJ3GEYJ 470 V (47Ω)
R95	7030003520	S.RESISTOR ERJ3GEYJ 472 V (4.7KΩ)
R96	7030003340	S.RESISTOR ERJ3GEYJ 151 V (150Ω)
R97	7030003250	S.RESISTOR ERJ3GEYJ 270 V (27Ω)
R98	7030003680	S.RESISTOR ERJ3GEYJ 104 V (100KΩ)
R99	7030003600	S.RESISTOR ERJ3GEYJ 223 V (22KΩ)
R100	7030003520	S.RESISTOR ERJ3GEYJ 472 V (4.7KΩ)
R101	7030003500	S.RESISTOR ERJ3GEYJ 332 V (3.3KΩ)
R102	7030003480	S.RESISTOR ERJ3GEYJ 222 V (2.2KΩ)
R103	7030003520	S.RESISTOR ERJ3GEYJ 472 V (4.7KΩ)
R104	7030003320	S.RESISTOR ERJ3GEYJ 101 V (100Ω)
R105	7030003480	S.RESISTOR ERJ3GEYJ 222 V (2.2KΩ)
R106	7030003520	S.RESISTOR ERJ3GEYJ 472 V (4.7KΩ)
R107	7030003290	S.RESISTOR ERJ3GEYJ 560 V (56Ω)
R108	7030000240	S.RESISTOR MCR10EZHJ .68 Ω (680)
R109	7030003260	S.RESISTOR ERJ3GEYJ 330 V (33Ω)
R110	7030003520	S.RESISTOR ERJ3GEYJ 472 V (4.7KΩ)
R111	7030000380	S.RESISTOR MCR10EZHJ 1 K Ω (102)
R112	7030003440	S.RESISTOR ERJ3GEYJ 102 V (1KΩ)
R113	7030003490	S.RESISTOR ERJ3GEYJ 272 V (2.7KΩ)
R114	7030003690	S.RESISTOR ERJ3GEYJ 124 V (120KΩ)
R115	7030003520	S.RESISTOR ERJ3GEYJ 472 V (4.7KΩ)
R116	7030003400	S.RESISTOR ERJ3GEYJ 471 V (470Ω)
R117	7010004830	RESISTOR R50XJ 4.7 Ω
R118	7030003360	S.RESISTOR ERJ3GEYJ 221 V (220Ω)
R119	7010004780	RESISTOR R50XJ 470 Ω
R120	7030003560	S.RESISTOR ERJ3GEYJ 103 V (10KΩ)
R121	7520000030	POSISTOR PTH59F04BG222TS (IC-3230H)
C1	4030008630	S.CERAMIC C1608 JF 1C 104Z-T-A
C2	4030006890	S.CERAMIC C1608 JF 1H 103Z-T-A
C3	4510002950	ELECTROL 50 SS 2.2μF
C4	4030008630	S.CERAMIC C1608 JF 1C 104Z-T-A
C5	4550002890	S.TANTALUM TESVA 1A 225M1-8L
C6	4610000380	TRIMMER ECR-GA020 E30
C7	4030008560	S.CERAMIC C1608 CH 1H 300J-T-A
C8	4030006860	S.CERAMIC C1608 JB 1H 102K-T-A
C9	4030004980	S.CERAMIC C2012 CH 1H 820J-T-A
C10	4030007090	S.CERAMIC C1608 CH 1H 470J-T-A
C11	4030008430	S.CERAMIC C1608 JF 1H 223Z-T-A
C12	4030006940	S.CERAMIC C1608 CH 1H 030C-T-A
C13	4030008430	S.CERAMIC C1608 JF 1H 223Z-T-A
C14	4030006860	S.CERAMIC C1608 JB 1H 102K-T-A
C15	4030006860	S.CERAMIC C1608 JB 1H 102K-T-A
C16	4030008430	S.CERAMIC C1608 JF 1H 223Z-T-A
C17	4030008680	S.CERAMIC C2012 JF 1C 105Z-T-A
C18	4030006850	S.CERAMIC C1608 JB 1H 471K-T-A
C19	4030006850	S.CERAMIC C1608 JB 1H 471K-T-A
C20	4030006850	S.CERAMIC C1608 JB 1H 471K-T-A
C21	4030006850	S.CERAMIC C1608 JB 1H 471K-T-A

[MAIN-B UNIT]

REF. NO.	PARTS NO.	DESCRIPTION
C22	4510002640	ELECTROL 25 SS 47μF
C23	4510002730	ELECTROL 10 SS 100μF
C24	4030006860	S.CERAMIC C1608 JB 1H 102K-T-A
C25	4030006860	S.CERAMIC C1608 JB 1H 102K-T-A
C26	4030006590	S.CERAMIC C1608 SL 1H 080D-T-A
C27	4030006860	S.CERAMIC C1608 JB 1H 102K-T-A
C28	4030006860	S.CERAMIC C1608 JB 1H 102K-T-A
C29	4030006570	S.CERAMIC C1608 SL 1H 060D-T-A
C30	4030006580	S.CERAMIC C1608 SL 1H 070D-T-A
C31	4030006580	S.CERAMIC C1608 SL 1H 070D-T-A
C32	4030006860	S.CERAMIC C1608 JB 1H 102K-T-A
C33	4030006860	S.CERAMIC C1608 JB 1H 102K-T-A
C34	4030006860	S.CERAMIC C1608 JB 1H 102K-T-A
C35	4030006860	S.CERAMIC C1608 JB 1H 102K-T-A
C36	4550000890	S.TANTALUM TESVC 1C 475M-12L
C37	4030006860	S.CERAMIC C1608 JB 1H 102K-T-A
C38	4030006660	S.CERAMIC C1608 SL 1H 220J-T-A
C39	4030006860	S.CERAMIC C1608 JB 1H 102K-T-A
C40	4030006550	S.CERAMIC C1608 SL 1H 040C-T-A
C41	4030006610	S.CERAMIC C1608 SL 1H 100D-T-A
C42	4030006860	S.CERAMIC C1608 JB 1H 102K-T-A
C43	4030006860	S.CERAMIC C1608 JB 1H 102K-T-A
C44	4030006860	S.CERAMIC C1608 JB 1H 102K-T-A
C45	4030006860	S.CERAMIC C1608 JB 1H 102K-T-A
C46	4030006660	S.CERAMIC C1608 SL 1H 220J-T-A (IC-3230A/E)
	4030006570	S.CERAMIC C1608 SL 1H 060D-T-A (IC-3230H)
C47	4030006570	S.CERAMIC C1608 SL 1H 060D-T-A
C48	4030006570	S.CERAMIC C1608 SL 1H 060D-T-A
C49	4030006860	S.CERAMIC C1608 JB 1H 102K-T-A
C50	4550000260	TANTALUM DN 1V 100M
C51	4030006860	S.CERAMIC C1608 JB 1H 102K-T-A
C52	4030006860	S.CERAMIC C1608 JB 1H 102K-T-A
C53	4030006860	S.CERAMIC C1608 JB 1H 102K-T-A
C54	4030006860	S.CERAMIC C1608 JB 1H 102K-T-A
C55	4030006860	S.CERAMIC C1608 JB 1H 102K-T-A
C56	4550000260	TANTALUM DN 1V 100M (IC-3230A/E)
	4550002120	TANTALUM DN 1C 220M (IC-3230H)
C57	4030006860	S.CERAMIC C1608 JB 1H 102K-T-A
C58	4030006850	S.CERAMIC C1608 JB 1H 471K-T-A
C59	4010005200	CERAMIC DD05 CH 050C 500V (IC-3230A/E)
	4010003820	CERAMIC DD06 SL 050C 500V (IC-3230H)
C60	4030006860	S.CERAMIC C1608 JB 1H 102K-T-A
C61	4030006860	S.CERAMIC C1608 JB 1H 102K-T-A
C62	4010005200	CERAMIC DD05 CH 050C 500V (IC-3230A/E)
	4010003820	CERAMIC DD06 SL 050C 500V (IC-3230H)
C63	4030006860	S.CERAMIC C1608 JB 1H 102K-T-A
C64	4030006860	S.CERAMIC C1608 JB 1H 102K-T-A
C65	4510002980	ELECTROL 50 SS 10μF
C66	4030006860	S.CERAMIC C1608 JB 1H 102K-T-A
C67	4010004110	CERAMIC DD05 B 471K 500V
C68	4030006860	S.CERAMIC C1608 JB 1H 102K-T-A
C69	4030006860	S.CERAMIC C1608 JB 1H 102K-T-A
C70	4030006860	S.CERAMIC C1608 JB 1H 102K-T-A
C71	4030006860	S.CERAMIC C1608 JB 1H 102K-T-A
C72	4010004110	CERAMIC DD05 B 471K 500V
C73	4030006860	S.CERAMIC C1608 JB 1H 102K-T-A
C74	4030006860	S.CERAMIC C1608 JB 1H 102K-T-A
C75	4010003820	CERAMIC DD06 SL 050C 500V
C76	4010003850	CERAMIC DD06 SL 080D 500V
C77	4010003830	CERAMIC DD06 SL 060D 500V
C78	4010003870	CERAMIC DD06 SL 120K 500V
C79	4010003820	CERAMIC DD06 SL 050C 500V
C80	4010003860	CERAMIC DD06 SL 100D 500V
C81	4030006860	S.CERAMIC C1608 JB 1H 102K-T-A
C82	4030006860	S.CERAMIC C1608 JF 1C 104Z-T-A

S. = Surface mount

[MAIN-B UNIT]

REF. NO.	PARTS NO.	DESCRIPTION
C83	4030008630	S.CERAMIC C1608 JF 1C 104Z-T-A
C84	4030008630	S.CERAMIC C1608 JF 1C 104Z-T-A
C85	4030006640	S.CERAMIC C1608 SL 1H 180J-T-A
C86	4030006720	S.CERAMIC C1608 SL 1H 560J-T-A
C87	4030006690	S.CERAMIC C1608 SL 1H 330J-T-A
C88	4030008680	S.CERAMIC C2012 JF 1C 105Z-T-A
C89	4030006860	S.CERAMIC C1608 JB 1H 102K-T-A
C90	4030008630	S.CERAMIC C1608 JF 1C 104Z-T-A
C91	4030006860	S.CERAMIC C1608 JB 1H 102K-T-A
C92	4030006860	S.CERAMIC C1608 JB 1H 102K-T-A
C93	4030006860	S.CERAMIC C1608 JB 1H 102K-T-A
C94	4030006860	S.CERAMIC C1608 JB 1H 102K-T-A
C95	4030006860	S.CERAMIC C1608 JB 1H 102K-T-A
C96	4030006860	S.CERAMIC C1608 JB 1H 102K-T-A
C97	4030006860	S.CERAMIC C1608 JB 1H 102K-T-A
C98	4030006860	S.CERAMIC C1608 JB 1H 102K-T-A
C99	4030006890	S.CERAMIC C1608 JF 1H 103Z-T-A
C100	4030006690	S.CERAMIC C1608 SL 1H 330J-T-A
C101	4030006860	S.CERAMIC C1608 JB 1H 102K-T-A
C102	4030006890	S.CERAMIC C1608 JF 1H 103Z-T-A
C103	4030006890	S.CERAMIC C1608 JF 1H 103Z-T-A
C104	4510002930	ELECTROL 50 SS R 47μF
C105	4030006890	S.CERAMIC C1608 JF 1H 103Z-T-A
C106	4030008630	S.CERAMIC C1608 JF 1C 104Z-T-A
C107	4030006860	S.CERAMIC C1608 JB 1H 102K-T-A
C108	4510002980	ELECTROL 50 SS 10μF
C109	4030006860	S.CERAMIC C1608 JB 1H 102K-T-A
C110	4030006710	S.CERAMIC C1608 SL 1H 470J-T-A
C111	4030006610	S.CERAMIC C1608 SL 1H 100D-T-A
C112	4030006890	S.CERAMIC C1608 JF 1H 103Z-T-A
C113	4030006660	S.CERAMIC C1608 SL 1H 220J-T-A
C114	4030006890	S.CERAMIC C1608 JF 1H 103Z-T-A
C115	4030006550	S.CERAMIC C1608 SL 1H 040C-T-A
C116	4020000660	CYLINDER UP125 SL 120J
C117	4030006850	S.CERAMIC C1608 JB 1H 471K-T-A
C118	4030006860	S.CERAMIC C1608 JB 1H 102K-T-A
C119	4030006850	S.CERAMIC C1608 JB 1H 471K-T-A
C120	4030006550	S.CERAMIC C1608 SL 1H 040C-T-A
C121	4030006860	S.CERAMIC C1608 JB 1H 102K-T-A
C122	4030006850	S.CERAMIC C1608 JB 1H 471K-T-A
C123	4030006850	S.CERAMIC C1608 JB 1H 471K-T-A
C124	4610001340	TRIMMER ECR-LA010 A12
C125	4030006180	S.CERAMIC C2012 JJ 1H 040C-T-A
C126	4030006860	S.CERAMIC C1608 JB 1H 102K-T-A
C127	4030006860	S.CERAMIC C1608 JB 1H 102K-T-A
C128	4030006860	S.CERAMIC C1608 JB 1H 102K-T-A
C129	4610001340	TRIMMER ECR-LA010 A12
C130	4030006550	S.CERAMIC C1608 SL 1H 040C-T-A
C131	4030006860	S.CERAMIC C1608 JB 1H 102K-T-A
C132	4030006690	S.CERAMIC C1608 SL 1H 330J-T-A
C133	4030006860	S.CERAMIC C1608 JB 1H 102K-T-A
C134	4030006550	S.CERAMIC C1608 SL 1H 040C-T-A
C135	4030006550	S.CERAMIC C1608 SL 1H 040C-T-A
C136	4030006860	S.CERAMIC C1608 JB 1H 102K-T-A
C137	4010005300	CERAMIC DD05 CH 060D 500V
C138	4030008630	S.CERAMIC C1608 JF 1C 104Z-T-A
C139	4030008630	S.CERAMIC C1608 JF 1C 104Z-T-A
C140	4510002940	ELECTROL 50 SS 1μF
C141	4030006850	S.CERAMIC C1608 JB 1H 471K-T-A
C142	4030006610	S.CERAMIC C1608 SL 1H 100D-T-A
C143	4030006560	S.CERAMIC C1608 SL 1H 050C-T-A
C144	4030006610	S.CERAMIC C1608 SL 1H 100D-T-A
C145	4030006860	S.CERAMIC C1608 JB 1H 102K-T-A
C146	4030008680	S.CERAMIC C2012 JF 1C 105Z-T-A
C147	4030006850	S.CERAMIC C1608 JB 1H 471K-T-A
C148	4030006860	S.CERAMIC C1608 JB 1H 102K-T-A
C149	4030006860	S.CERAMIC C1608 JB 1H 102K-T-A
C151	4030006850	S.CERAMIC C1608 JB 1H 471K-T-A
C152	4030008680	S.CERAMIC C2012 JF 1C 105Z-T-A
C153	4030008680	S.CERAMIC C2012 JF 1C 105Z-T-A
C154	4030006750	S.CERAMIC C1608 SL 1H 101J-T-A

[MAIN-B UNIT]

REF. NO.	PARTS NO.	DESCRIPTION
C155	4030006750	S.CERAMIC C1608 SL 1H 101J-T-A
C156	4030006750	S.CERAMIC C1608 SL 1H 101J-T-A
C157	4030006750	S.CERAMIC C1608 SL 1H 101J-T-A
C158	4030006750	S.CERAMIC C1608 SL 1H 101J-T-A
C159	4030006750	S.CERAMIC C1608 SL 1H 101J-T-A
C160	4030006750	S.CERAMIC C1608 SL 1H 101J-T-A
C161	4030006750	S.CERAMIC C1608 SL 1H 101J-T-A
C162	4030006750	S.CERAMIC C1608 SL 1H 101J-T-A
C163	4030006750	S.CERAMIC C1608 SL 1H 101J-T-A
C164	4030006750	S.CERAMIC C1608 SL 1H 101J-T-A
C165	4030006750	S.CERAMIC C1608 SL 1H 101J-T-A
C166	4030006750	S.CERAMIC C1608 SL 1H 101J-T-A
C167	4030006750	S.CERAMIC C1608 SL 1H 101J-T-A
C168	4510002640	ELECTROL 25 SS 47μF
C169	4030008630	S.CERAMIC C1608 JF 1C 104Z-T-A
C170	4030008630	S.CERAMIC C1608 JF 1C 104Z-T-A
C171	4030008680	S.CERAMIC C2012 JF 1C 105Z-T-A
C172	4510003150	ELECTROL 35 SS 33μF
C173	4510003150	ELECTROL 35 SS 33μF
C174	4510003150	ELECTROL 35 SS 33μF
C175	4550000320	TANTALUM DN 1V 0R1M
C176	4030006860	S.CERAMIC C1608 JB 1H 102K-T-A
C177	4510002870	ELECTROL 25 SS 100μF
C178	4510002870	ELECTROL 25 SS 100μF
C179	4030008630	S.CERAMIC C1608 JF 1C 104Z-T-A
C180	4510002640	ELECTROL 25 SS 47μF
C181	4510002640	ELECTROL 25 SS 47μF
C182	4030008630	S.CERAMIC C1608 JF 1C 104Z-T-A
C183	4510002730	ELECTROL 10 SS 100μF
C184	4030008630	S.CERAMIC C1608 JF 1C 104Z-T-A
C185	4030008630	S.CERAMIC C1608 JF 1C 104Z-T-A
C186	4510002640	ELECTROL 25 SS 47μF
C187	4510002380	ELECTROL 16 SS 470μF (10X12.5)
C188	4030008630	S.CERAMIC C1608 JF 1C 104Z-T-A
C189	4030008630	S.CERAMIC C1608 JF 1C 104Z-T-A
C190	4030008630	S.CERAMIC C1608 JF 1C 104Z-T-A
C191	4030006860	S.CERAMIC C1608 JB 1H 102K-T-A
C192	4030006860	S.CERAMIC C1608 JB 1H 102K-T-A
C193	4030008630	S.CERAMIC C1608 JF 1C 104Z-T-A
C194	4030008630	S.CERAMIC C1608 JF 1C 104Z-T-A
C195	4030006860	S.CERAMIC C1608 JB 1H 102K-T-A
C196	4030006860	S.CERAMIC C1608 JB 1H 102K-T-A
C197	4510002980	ELECTROL 50 SS 10μF
C198	4030006870	S.CERAMIC C1608 JB 1H 222K-T-A
C199	4030006520	S.CERAMIC C1608 SL 1H 010C-T-A
C200	4030006860	S.CERAMIC C1608 JB 1H 102K-T-A
EP1	910035361	PCB B 3569A
EP11	6910000630	BEAD FSOH070RN (IC-3230H)

[VCO-B UNIT]

REF. NO.	PARTS NO.	DESCRIPTION
IC1	1130004200	S.IC TC4S66F (TE85R)
IC2	1130005700	S.IC M56760FP
Q1	1560000650	S.FET 2SK1577-2-T7
Q2	1530002240	S.TRANSISTOR 2SC3775-3-TA
Q3	1590000480	S.TRANSISTOR RN2402 (TE85R)
Q4	1530000160	S.TRANSISTOR 2SC2712-Y (TE85RTEM)
Q5	1560000360	S.FET 2SK209-Y (TE85R)
Q6	1530002490	S.TRANSISTOR 2SC3324-GR (TE85R)
Q7	1530002030	S.TRANSISTOR 2SC3772-3-TA

S. = Surface mount

[VCO-B UNIT]

[B-BAND UNIT]

REF. NO.	PARTS NO.	DESCRIPTION	
D1	1720000220	S.VARICAP	1SV166-T2B
D2	1720000220	S.VARICAP	1SV166-T2B
L1	6200001560	S.COIL	LER 015T R68M
L2	6200001560	S.COIL	LER 015T R68M
L3	6130002450	S.COIL	LB-273
L4	6200001570	S.COIL	LER 015T 1R0M
L5	6200001570	S.COIL	LER 015T 1R0M
L6	6200001230	S.COIL	MLF2012A 1R0M-T
R1	7030003320	S.RESISTOR	ERJ3GEYJ 101 V (100Ω)
R2	7030003280	S.RESISTOR	ERJ3GEYJ 470 V (47Ω)
R3	7030003320	S.RESISTOR	ERJ3GEYJ 101 V (100Ω)
R4	7030003560	S.RESISTOR	ERJ3GEYJ 103 V (10KΩ)
R5	7030003310	S.RESISTOR	ERJ3GEYJ 820 V (82Ω)
R6	7030003400	S.RESISTOR	ERJ3GEYJ 471 V (470Ω)
R7	7030003480	S.RESISTOR	ERJ3GEYJ 222 V (2.2KΩ)
R8	7030003520	S.RESISTOR	ERJ3GEYJ 472 V (4.7KΩ)
R9	7030003400	S.RESISTOR	ERJ3GEYJ 471 V (470Ω)
R10	7030003480	S.RESISTOR	ERJ3GEYJ 222 V (2.2KΩ)
R11	7030003520	S.RESISTOR	ERJ3GEYJ 472 V (4.7KΩ)
R12	7030003640	S.RESISTOR	ERJ3GEYJ 473 V (47KΩ)
R13	7030003560	S.RESISTOR	ERJ3GEYJ 103 V (10KΩ)
R14	7030003520	S.RESISTOR	ERJ3GEYJ 472 V (4.7KΩ)
R15	7030003640	S.RESISTOR	ERJ3GEYJ 473 V (47KΩ)
R16	7030003320	S.RESISTOR	ERJ3GEYJ 101 V (100Ω)
R17	7030003540	S.RESISTOR	ERJ3GEYJ 682 V (6.8KΩ)
R18	7030003450	S.RESISTOR	ERJ3GEYJ 122 V (1.2KΩ)
R19	7030003410	S.RESISTOR	ERJ3GEYJ 561 V (560Ω)
R20	7030000460	S.RESISTOR	MCR10EZHZ 4.7K Ω (472)
R21	7030003360	S.RESISTOR	ERJ3GEYJ 221 V (220Ω)
R22	7030003520	S.RESISTOR	ERJ3GEYJ 472 V (4.7KΩ)
R23	7030003220	S.RESISTOR	ERJ3GEYJ 150 V (15Ω)
R24	7030003220	S.RESISTOR	ERJ3GEYJ 150 V (15Ω)
R25	7030003220	S.RESISTOR	ERJ3GEYJ 150 V (15Ω)
R26	7030003480	S.RESISTOR	ERJ3GEYJ 222 V (2.2KΩ)
R27	7030003520	S.RESISTOR	ERJ3GEYJ 472 V (4.7KΩ)
R28	7030003400	S.RESISTOR	ERJ3GEYJ 471 V (470Ω)
C1	4030006860	S.CERAMIC	C1608 JB 1H 102K-T-A
C2	4030007110	S.CERAMIC	C1608 CH 1H 680J-T-A
C3	4030006860	S.CERAMIC	C1608 JB 1H 102K-T-A
C4	4030006550	S.CERAMIC	C1608 SL 1H 040C-T-A
C5	4030006860	S.CERAMIC	C1608 JB 1H 102K-T-A
C6	4030006910	S.CERAMIC	C1608 CH 1H 0R5C-T-A
C7	4030006900	S.CERAMIC	C1608 JB 1E 103K-T-A
C8	4030006610	S.CERAMIC	C1608 SL 1H 100D-T-A
C9	4030006890	S.CERAMIC	C1608 JF 1H 103Z-T-A
C10	4030006850	S.CERAMIC	C1608 JB 1H 471K-T-A
C11	4030008680	S.CERAMIC	C2012 JF 1C 105Z-T-A
C12	4030008680	S.CERAMIC	C2012 JF 1C 105Z-T-A
C13	4030005110	S.CERAMIC	C2012 JB 1E 473K-T-A
C14	4030006900	S.CERAMIC	C1608 JB 1E 103K-T-A
C15	4550000940	S.TANTALUM	TESVB2 1D 225M-8L
C16	4550000940	S.TANTALUM	TESVB2 1D 225M-8L
C17	4030006900	S.CERAMIC	C1608 JB 1E 103K-T-A
C18	4550000550	S.TANTALUM	TESVA 1V 224M1-8L
C19	4030006860	S.CERAMIC	C1608 JB 1H 102K-T-A
C20	4030006850	S.CERAMIC	C1608 JB 1H 471K-T-A
C21	4030008630	S.CERAMIC	C1608 JF 1C 104Z-T-A
C22	4030006860	S.CERAMIC	C1608 JB 1H 102K-T-A
C23	4030007010	S.CERAMIC	C1608 CH 1H 100D-T-A
C24	4030006860	S.CERAMIC	C1608 JB 1H 102K-T-A
C25	4030006860	S.CERAMIC	C1608 JB 1H 102K-T-A
C26	4030006660	S.CERAMIC	C1608 SL 1H 220J-T-A
EP1	910032970	PCB	B 3290

REF. NO.	PARTS NO.	DESCRIPTION	
Q1	1530002430	S.TRANSISTOR	2SC4315 (TE85R)
Q2	1580000360	S.FET	3SK177-T2B U73
Q3	1590000420	S.TRANSISTOR	RN1404 (TE85R)
Q4	1530002240	S.TRANSISTOR	2SC3775-3-TA
D1	1750000080	S.DIODE	1SS153-T2
L1	6200000720	S.COIL	LQN 2A 10NM
R1	7030003540	S.RESISTOR	ERJ3GEYJ 682 V (6.8KΩ)
R2	7030003600	S.RESISTOR	ERJ3GEYJ 223 V (22KΩ)
R3	7030003360	S.RESISTOR	ERJ3GEYJ 221 V (220Ω)
R4	7030003560	S.RESISTOR	ERJ3GEYJ 103 V (10KΩ)
R5	7030003340	S.RESISTOR	ERJ3GEYJ 151 V (150Ω)
R6	7030003560	S.RESISTOR	ERJ3GEYJ 103 V (10KΩ)
R7	7030003320	S.RESISTOR	ERJ3GEYJ 101 V (100Ω)
R8	7030003440	S.RESISTOR	ERJ3GEYJ 102 V (1KΩ)
R9	7030003560	S.RESISTOR	ERJ3GEYJ 103 V (10KΩ)
R10	7030003440	S.RESISTOR	ERJ3GEYJ 102 V (1KΩ)
C1	4030006540	S.CERAMIC	C1608 SL 1H 030C-T-A
C2	4030006540	S.CERAMIC	C1608 SL 1H 030C-T-A
C3	4030006540	S.CERAMIC	C1608 SL 1H 030C-T-A
C4	4030006860	S.CERAMIC	C1608 JB 1H 102K-T-A
C5	4030006550	S.CERAMIC	C1608 SL 1H 040C-T-A
C6	4030006550	S.CERAMIC	C1608 SL 1H 040C-T-A
C7	4030006700	S.CERAMIC	C1608 SL 1H 390J-T-A
C8	4030006860	S.CERAMIC	C1608 JB 1H 102K-T-A
C9	4030006540	S.CERAMIC	C1608 SL 1H 030C-T-A
C10	4030006860	S.CERAMIC	C1608 JB 1H 102K-T-A
C11	4030006860	S.CERAMIC	C1608 JB 1H 102K-T-A
EP1	910030691	PCB	B 2379A
EP2	6910003330	LEADFRAM	PD2.0-0.9-8

[TONE UNIT] (#25 only)

REF. NO.	PARTS NO.	DESCRIPTION	
IC1	1130005100	S.IC	FX365LG
X1	6060000480	CERAMIC	CSB1000J221T
R1	7030003560	S.RESISTOR	ERJ3GEYJ 103 V (10KΩ)
R2	7030003580	S.RESISTOR	ERJ3GEYJ 153 V (15KΩ)
R3	7310002600	S.TRIMMER	RV-110 (RH03A3AS4X0AA) 473
R4	7030003800	S.RESISTOR	ERJ3GEYJ 105 V (1MΩ)
R5	7030003680	S.RESISTOR	ERJ3GEYJ 104 V (100KΩ)
R6	7030003680	S.RESISTOR	ERJ3GEYJ 104 V (100KΩ)
R7	7030003560	S.RESISTOR	ERJ3GEYJ 103 V (10KΩ)
C1	4550000420	S.TANTALUM	TESVA 1A 105M1-8L
C2	4030008430	S.CERAMIC	C1608 JF 1H 223Z-T-A
C3	4030007170	S.CERAMIC	C1608 CH 1H 221J-T-A
C4	4030007170	S.CERAMIC	C1608 CH 1H 221J-T-A
C5	4550002950	S.TANTALUM	TESVA 0J 335M1-8L
EP1	910031021	PCB	B 3139A

S. = Surface mount

SECTION 6 ADJUSTMENT PROCEDURES

6-1 PREPARATION BEFORE SERVICING

REQUIRED TEST EQUIPMENT

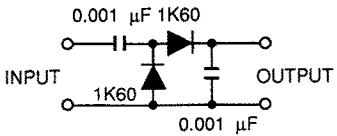
EQUIPMENT	GRADE AND RANGE	EQUIPMENT	GRADE AND RANGE
DC power supply	Output voltage : 13.8 V DC Current capacity : 15 A or more	Audio generator	Frequency range : 300 ~ 3000 Hz Output level : 1 ~ 500 mV
RF power meter (terminated type)	Measuring range : 1 ~ 60 W Frequency range : 120 ~ 460 MHz Impedance : 50 Ω SWR : Less than 1.2 : 1	Attenuator	Power attenuation : 40 or 50 dB Capacity : 60 W or more
Frequency counter	Frequency range : 0.1 ~ 460 MHz Frequency accuracy : ± 1 ppm or better Sensitivity : 100 mV or better	Sweep generator	Frequency range : 0.1 ~ 460 MHz Sweep bandwidth : At least 10 MHz Output impedance : 50 Ω
Oscilloscope	Frequency range : DC ~ 20 MHz Measuring range : 0.01 ~ 100V	Detector	
Standard signal generator (SSG)	Frequency range : 0.1 ~ 460 MHz Output level : -127 ~ -17 dBm (0.1 μV ~ 32 mV)	FM deviation meter	Frequency minimum : 460 MHz Measuring range : 0 ~ ±10 kHz
DC voltmeter	Input impedance : 50 kΩ/DC or better		

CW: Clockwise CCW: Counterclockwise CP: Check point

CONNECTIONS

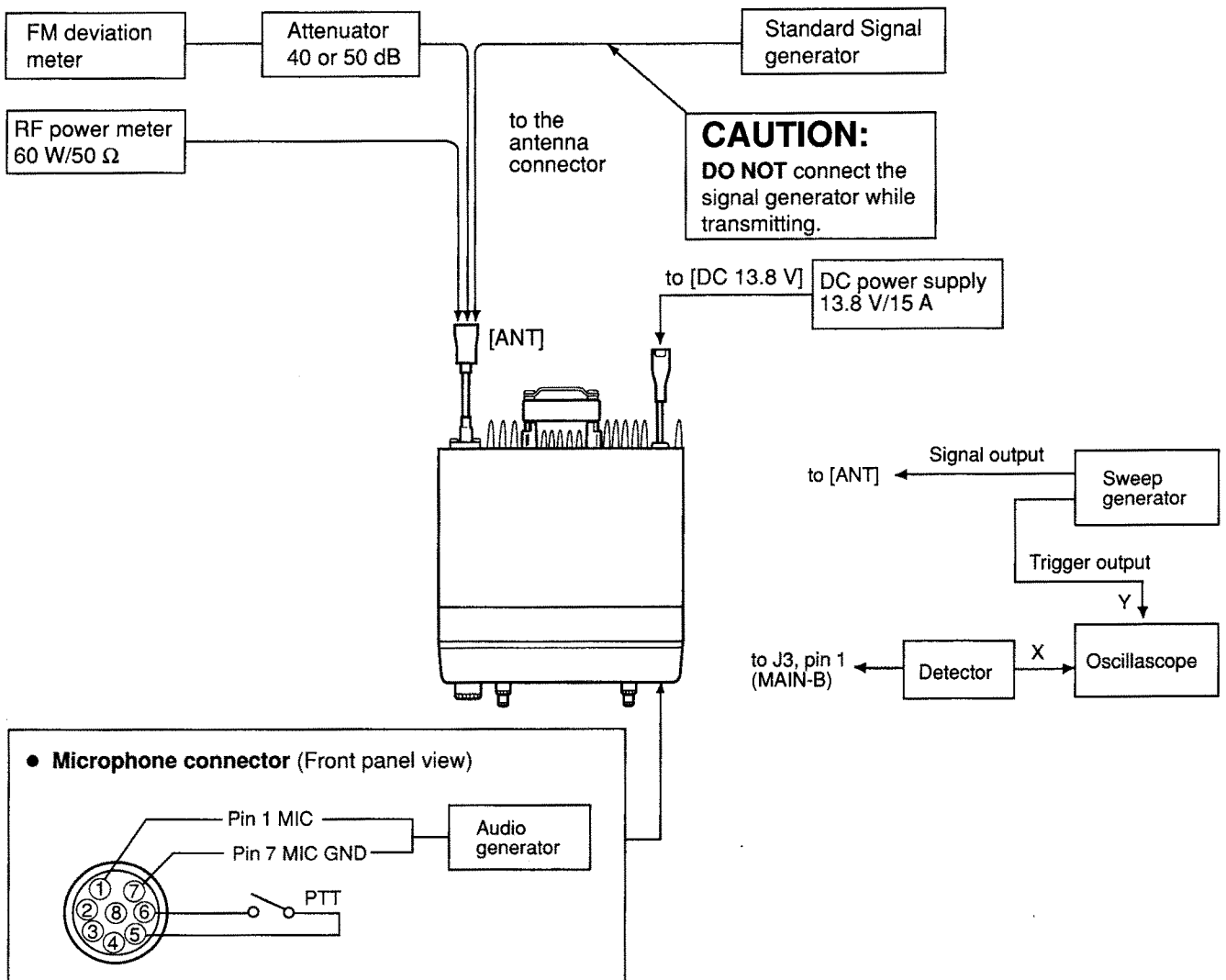

6-2 PLL ADJUSTMENT

ADJUSTMENT		ADJUSTMENT CONDITIONS	MEASUREMENT		VALUE	ADJUSTMENT POINT	
			UNIT	LOCATION		UNIT	ADJUST
REFERENCE FREQUENCY	1	<ul style="list-style-type: none"> ● Displayed frequency [U DISPLAY]: 445.0000 MHz (USA version) 435.0000 MHz (All other versions) ● Connect the RF power meter or a 50 Ω dummy load to the antenna connector. ● Simplex ● Transmitting 	Rear panel	Loosely couple the frequency counter to the antenna connector.	445.0000 MHz (USA version) 435.0000 MHz (All other versions)	MAIN-B	C6
VHF LOCK VOLTAGE	1	<ul style="list-style-type: none"> ● Displayed frequency [V DISPLAY]: 145.0000 MHz ● Receiving 	MAIN-A	Connect the DC voltmeter to CP-A1	7.5 V	MAIN-A (VCO-A)	L4
UHF LOCK VOLTAGE	1	<ul style="list-style-type: none"> ● Displayed frequency [U DISPLAY]: 445.0000 MHz (USA version) 435.0000 MHz (All other versions) ● Receiving 	MAIN-B	Connect the DC voltmeter to CP-B1	10 V \pm 0.5 V (USA version) 9.0 V \pm 0.5 V (All other versions)	MAIN-B	Verify

• MAIN-A UNIT

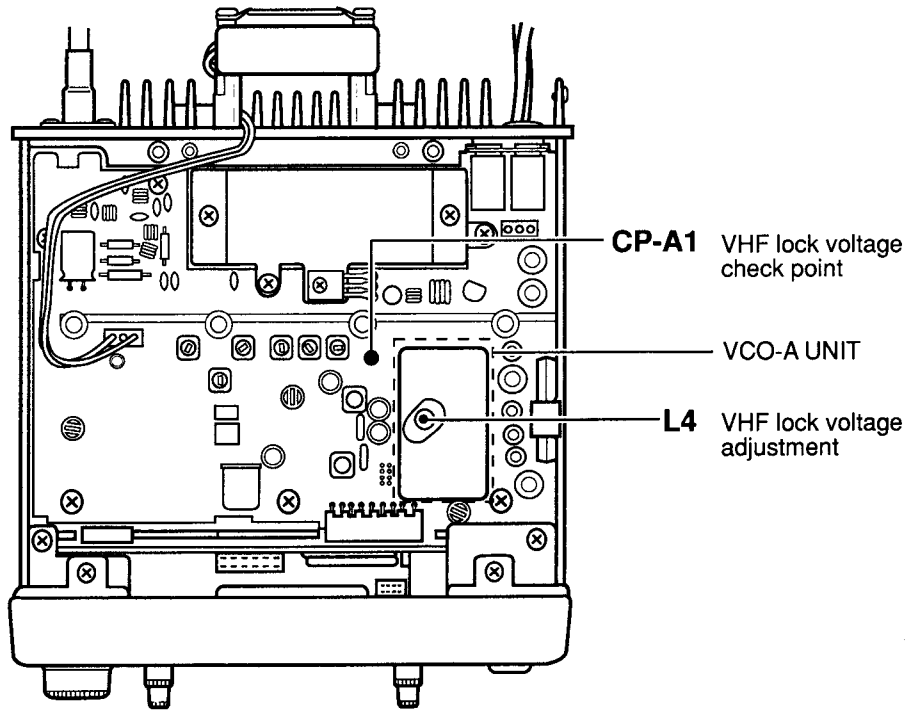

• MAIN-B UNIT

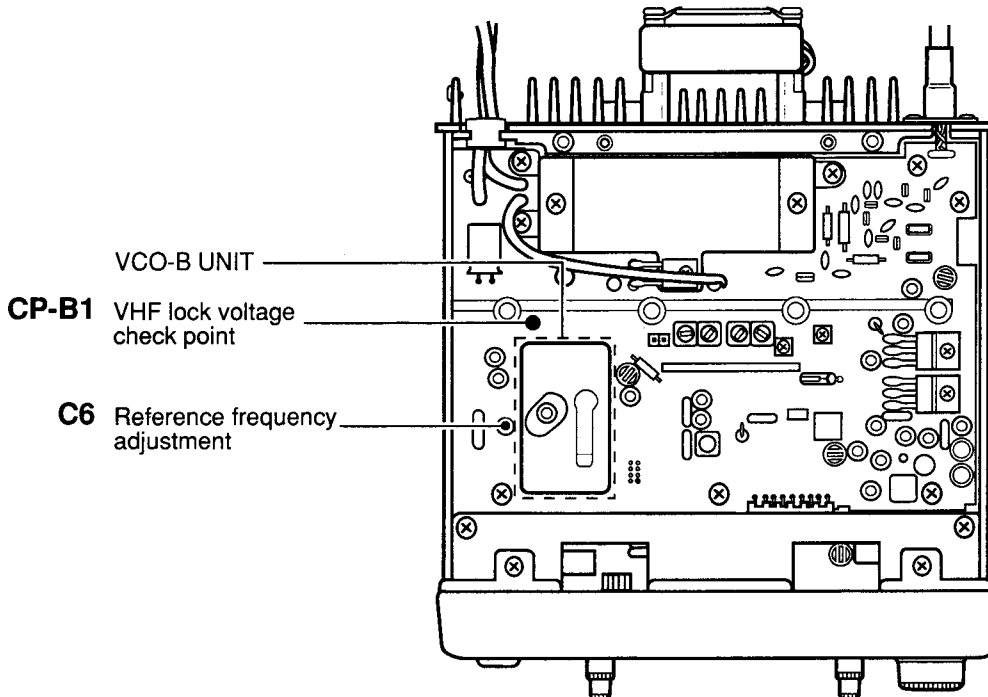

6-3 RECEIVER ADJUSTMENT

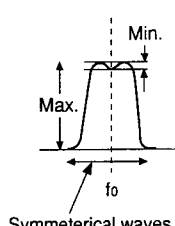
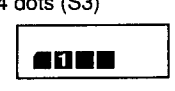
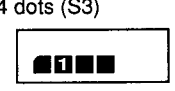
ADJUSTMENT	ADJUSTMENT CONDITIONS	MEASUREMENT		VALUE	ADJUSTMENT POINT		
		UNIT	LOCATION		UNIT	ADJUST	
VHF SENSITIVITY	1	<ul style="list-style-type: none"> Displayed frequency [V DISPLAY]: 146.0000 MHz (USA version) 145.0000 MHz (All other versions) Connect the SSG to the antenna connector and set as: Level : 1.0 μV (-107 dBm) Modulation : 1 kHz Deviation : \pm3.5 kHz R75 (MAIN-A) : Max. CW Receiving 	MAIN-A	Connect the DC voltmeter to CP-A2.	Maximum	MAIN-A	Adjust in sequence L20, L19, L18, L17
	2	<ul style="list-style-type: none"> Displayed frequency [V DISPLAY]: 146.0000 MHz (USA version) 145.0000 MHz (All other versions) Set the SSG as: Deviation : \pm7.0 kHz 	MAIN-A	Connect the DC voltmeter to CP-A2.	Maximum	MAIN-A	Adjust in sequence L16, L15
	NOTE: Adjust the standard signal generator output level so that the DC voltmeter needle remains at all times in the lowest 30 % of the full range.						
UHF SENSITIVITY	1	<ul style="list-style-type: none"> Displayed frequency [U DISPLAY]: 445.0000 MHz (USA version) 435.0000 MHz (All other versions) Connect the sweep generator to the antenna connector and set as: Sweep level : 22 mV* (-20 dBm) Center frequency: Same as the displayed frequency Sweep bandwidth: 10 MHz or 20 MHz Receiving 	MAIN-B	Connect the oscilloscope to J3, pin 1 via the detector.	Adjust as follows:	MAIN-B	C129, C124, L19, L18
				 <p>Symmetrical waves</p>			
	2	<ul style="list-style-type: none"> Connect the SSG to the antenna connector and set as: Level : 1.0 μV (-107 dBm) Modulation : 1 kHz Deviation : \pm7.0 kHz R77 (MAIN-B) : Max. CW 		Connect the DC voltmeter to CP-B2.	Maximum		L15, L14
NOTE: Adjust the standard signal generator output level so that the DC voltmeter needle remains at all times in the lowest 30 % of the full range.							
S-METER	1	<ul style="list-style-type: none"> Displayed frequency [V DISPLAY]: 146.0000 MHz (USA version) 145.0000 MHz (All other versions) Connect the SSG to the antenna connector and set as: Level : 1.0 μV* (-107 dBm) Modulation : 1 kHz Deviation : \pm3.5 kHz Receiving 	Function display	S indicator [V DISPLAY]	4 dots (S3)	MAIN-A	R75
							
2	<ul style="list-style-type: none"> Displayed frequency [U DISPLAY]: 445.0000 MHz (USA version) 435.0000 MHz (All other versions) 		S indicator [U DISPLAY]	4 dots (S3)	MAIN-B	R77	
							

* This output level of the standard signal generator (SSG) is indicated as SSG's open circuit.

• MAIN-A UNIT

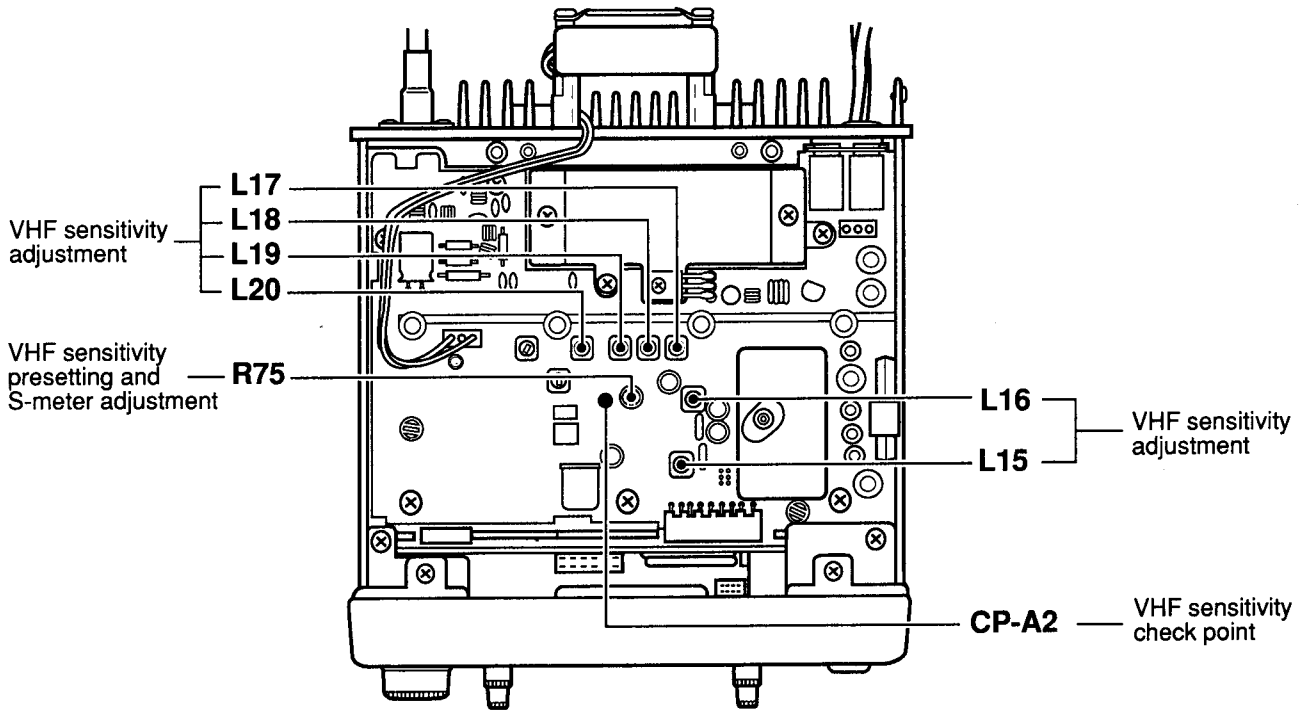

• MAIN-B UNIT

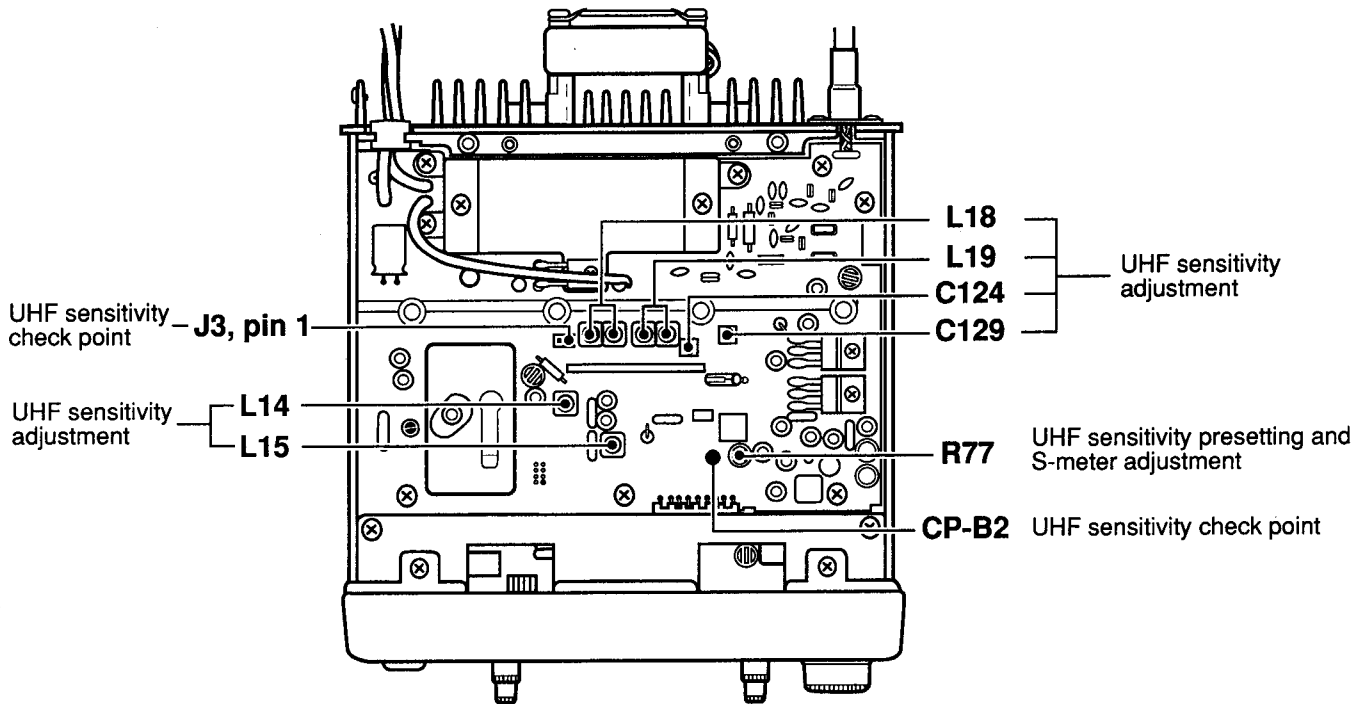

6-4 TRANSMITTER ADJUSTMENT

ADJUSTMENT	ADJUSTMENT CONDITIONS	MEASUREMENT		VALUE	ADJUSTMENT POINT			
		UNIT	LOCATION		UNIT	ADJUST		
VHF OUTPUT POWER	1	<ul style="list-style-type: none"> Displayed frequency [V DISPLAY]: 146.0000 MHz (USA version) 145.0000 MHz (All other versions) [HI/LOW] switch : HI Simplex Transmitting 	Rear panel	Connect the RF power meter to the antenna connector.	25 W (IC-3230A/E) 45 W (IC-3230H)	MAIN-A	R30	
	2	<ul style="list-style-type: none"> [HI/LOW] switch : LOW1 					1 W (IC-3230A/E) 5 W (IC-3230H)	Verify
	3	<ul style="list-style-type: none"> [HI/LOW] switch : LOW2 					10 W (IC-3230A/E/H)	
UHF OUTPUT POWER	1	<ul style="list-style-type: none"> Displayed frequency [U DISPLAY]: 445.0000 MHz (USA version) 435.0000 MHz (All other versions) [HI/LOW] switch : HI 			25 W (IC-3230A/E) 35 W (IC-3230H)	MAIN-B	R36	
	2	<ul style="list-style-type: none"> [HI/LOW] switch : LOW1 					1 W (IC-3230A/E) 5 W (IC-3230H)	Verify
	3	<ul style="list-style-type: none"> [HI/LOW] switch : LOW2 					10 W (IC-3230A/E/H)	
DEVIATION	1	<ul style="list-style-type: none"> Displayed frequency [V DISPLAY]: 146.0000 MHz (USA version) 145.0000 MHz (All other versions) [HI/LOW] switch : HI [T/T. SQL] switch : OFF Connect the audio generator to the microphone connector and set as: 65 mV/1.0 kHz (USA version) 20 mV/1.0 kHz (All other versions) Set the FM deviation meter as: HPF : 50 Hz LPF : 20 kHz De-emphasis : OFF Detector : (P-P)/2 Transmitting 	Rear panel	Connect the FM deviation meter to the antenna connector via the attenuator.	±4.8 kHz	MAIN-A	R5	
	2	<ul style="list-style-type: none"> Displayed frequency [U DISPLAY]: 445.0000 MHz (USA version) 435.0000 MHz (All other versions) 					±4.8 kHz	MAIN-B
TONE DEVIATION (USA only)	1	<ul style="list-style-type: none"> Displayed frequency [U DISPLAY]: 445.0000 MHz [T/T. SQL] switch : ON Apply no signal to the microphone connector. Set the tone frequency as : 88.5 Hz Set the FM deviation meter as: HPF : OFF LPF : 20 kHz De-emphasis : OFF Detector : (P-P)/2 Transmitting 	Rear panel	Connect the FM deviation meter to the antenna connector via the attenuator.	±0.8 kHz	TONE (UT-63)	R3	

• MAIN-A UNIT

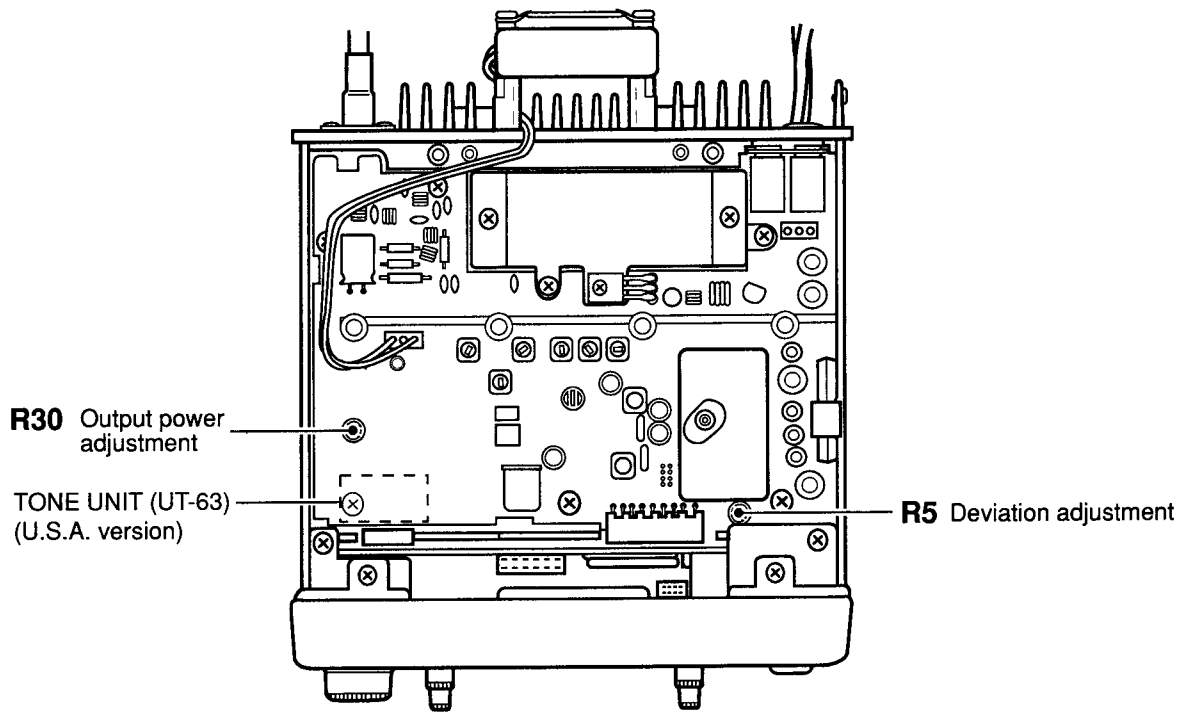

• MAIN-B UNIT

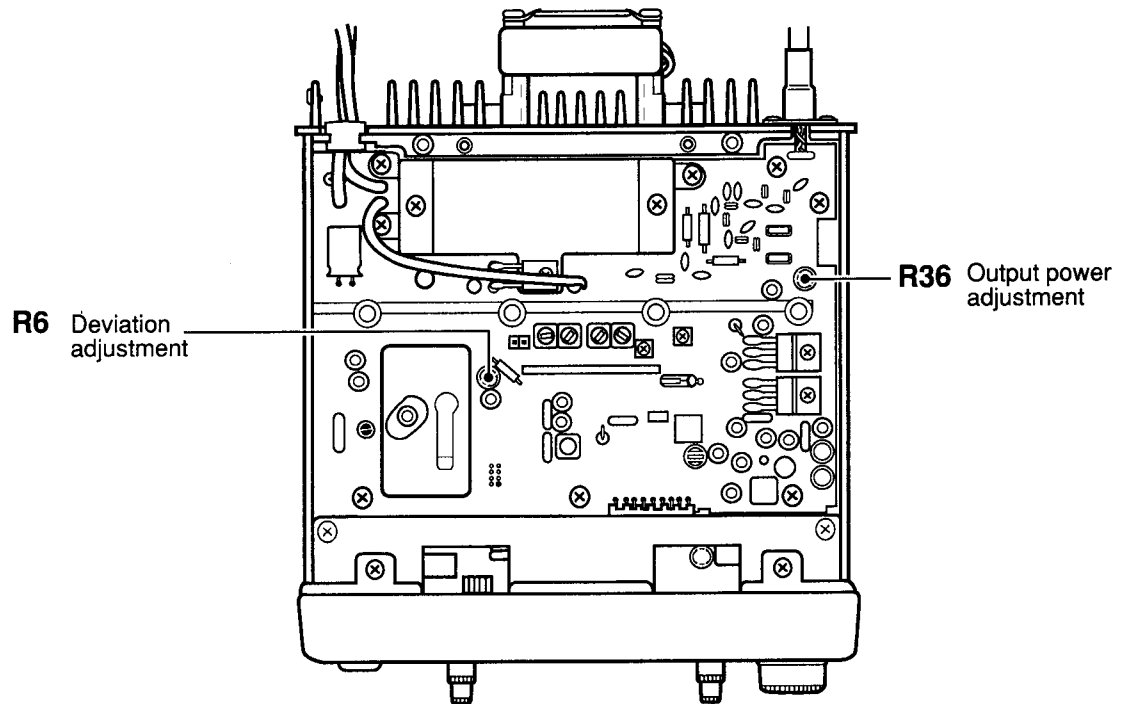

SECTION 7 BOARD LAYOUTS

7-1 LOGIC UNIT, VR-A UNIT AND VR-B UNITS

• LOGIC UNIT (TOP VIEW)

• VR-A UNIT (TOP VIEW)

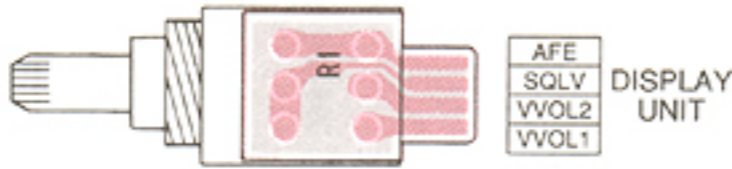

• VR-B UNIT (TOP VIEW)

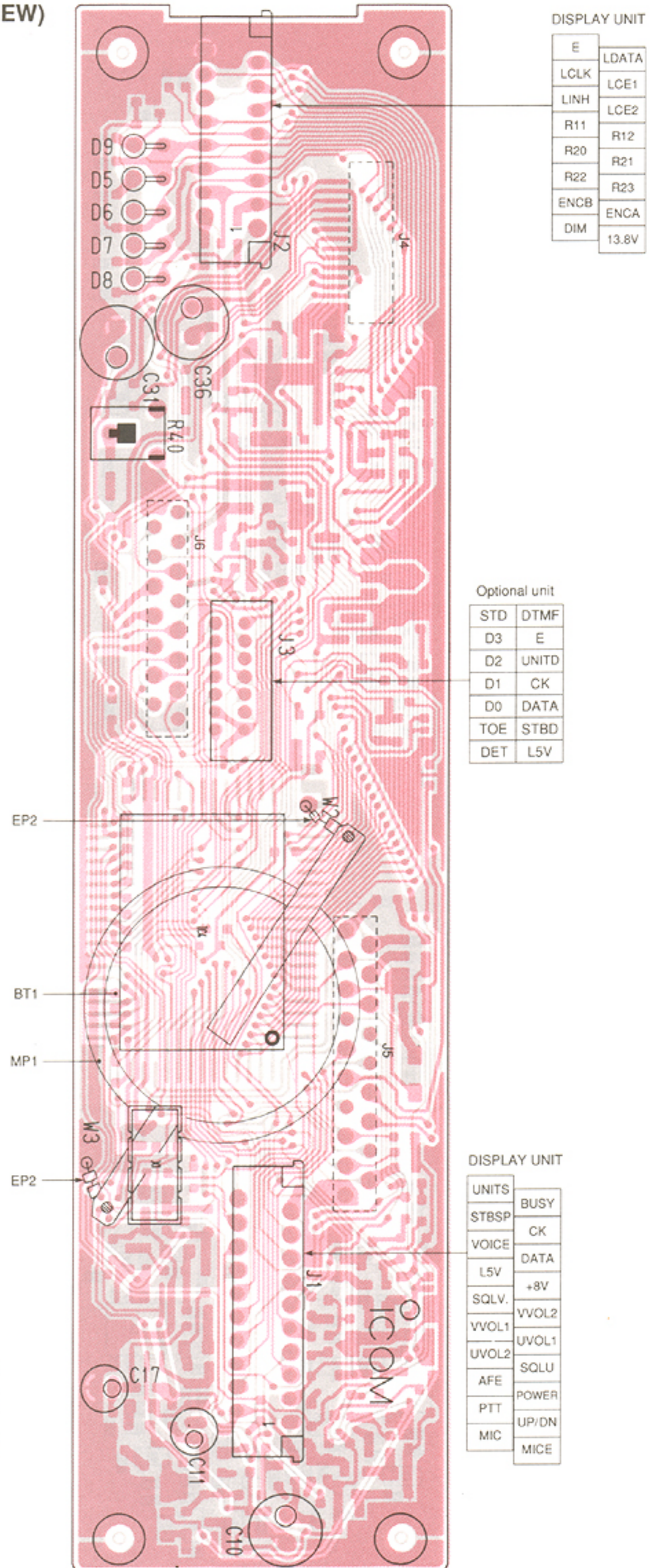
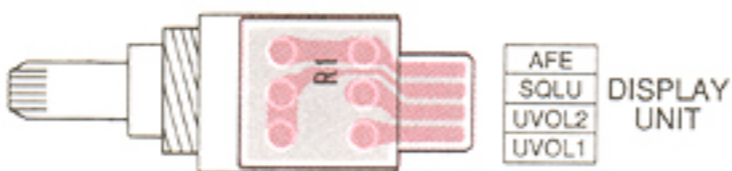

DISPLAY UNIT

E	LDATA
LCLK	LCE1
LINH	LCE2
R11	R12
R20	R21
R22	R23
ENCB	ENCA
DIM	13.8V

Optional unit

STD	DTMF
D3	E
D2	UNITD
D1	CK
D0	DATA
TOE	STBD
DET	L5V

DISPLAY UNIT

UNITS	BUSY
STBSP	CK
VOICE	DATA
L5V	+8V
SQLV	VVOL2
VVOL1	UVOL1
UVOL2	SQLU
AFE	POWER
PTT	UP/DN
MIC	MICE

The combination of this page and the next page shows the unit layout in the same configuration as the actual P.C. Board.

• LOGIC UNIT (BOTTOM VIEW)

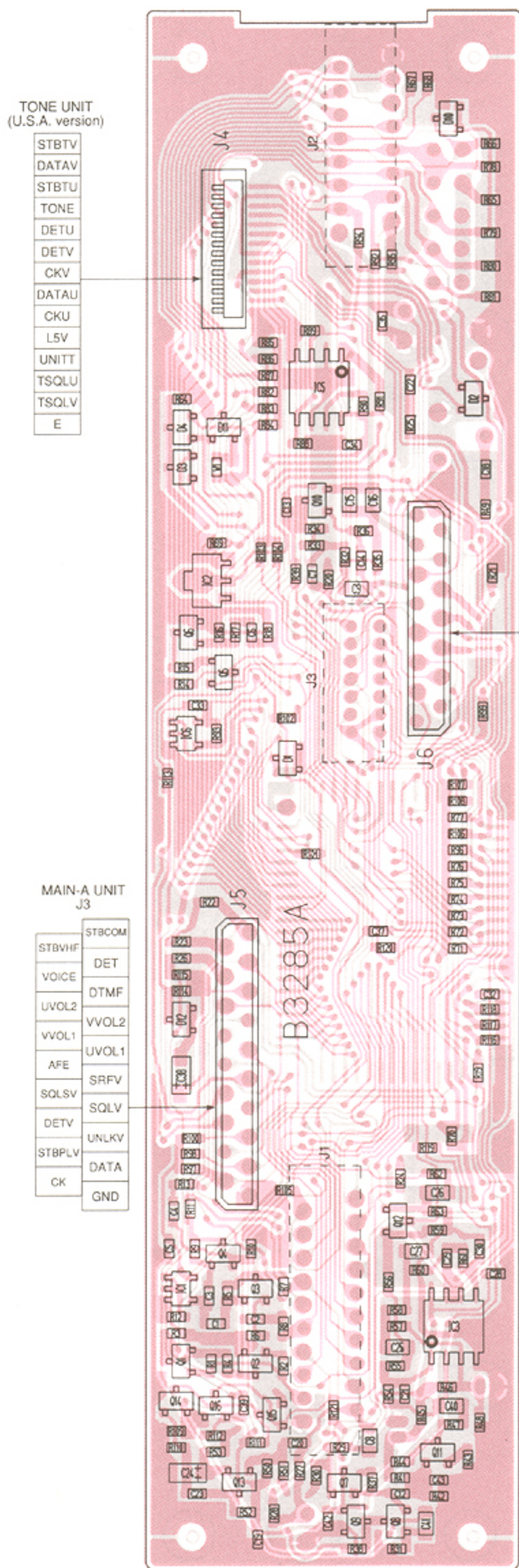

TONE UNIT
(U.S.A. version)

- STBTU
- DATAV
- STBTU
- TONE
- DETU
- DETV
- CKV
- DATAU
- CKU
- L5V
- UNITT
- TSQUL
- TSQLV
- E

MAIN-A UNIT
J3

- STBVHF
- VOICE
- UVOL2
- VVOL1
- AFE
- SQLSV
- DETV
- STBPLV
- CK
- STBCOM
- DET
- DTMF
- VVOL2
- UVOL1
- SRFV
- SQLV
- UNLKV
- DATA
- GND

MAIN-B UNIT
J2

- POWER
- 13.8V
- DETV
- SRFU
- UNLKV
- STBPLU
- CK
- GND
- SQLU
- SQLSU
- STBUHF
- +8V
- MOD
- DATA
- +5V

• VR-A (BOTTOM VIEW)

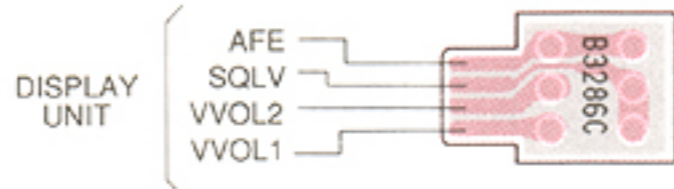

• VR-B (BOTTOM VIEW)

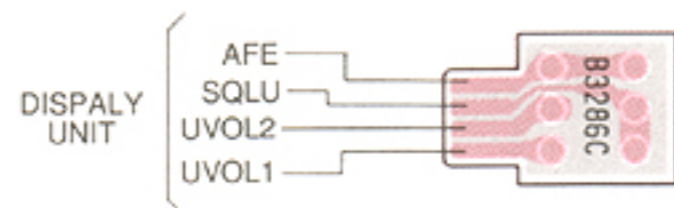

2SA1162

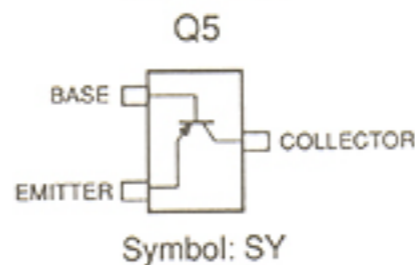

2SC2712GR

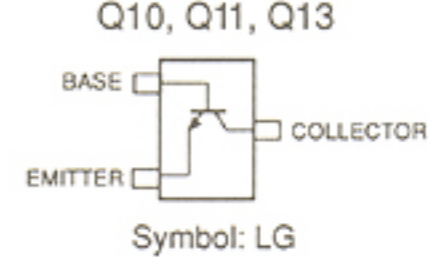

2SC2712 Y

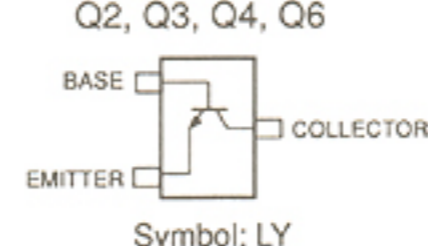

RN1404

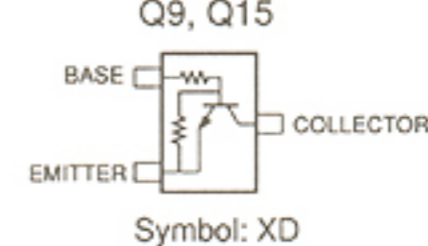

RN2404

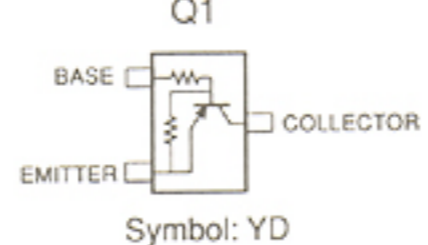

2SJ106 Y

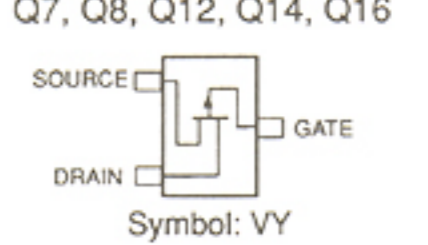

1SS181



1SS187



1SS226

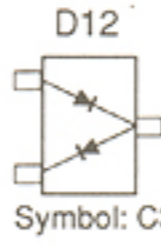

1SS190

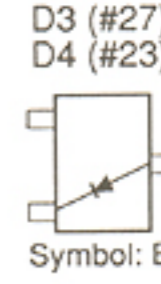

7-2 DISPLAY UNIT

• DISPLAY UNIT (TOP VIEW)

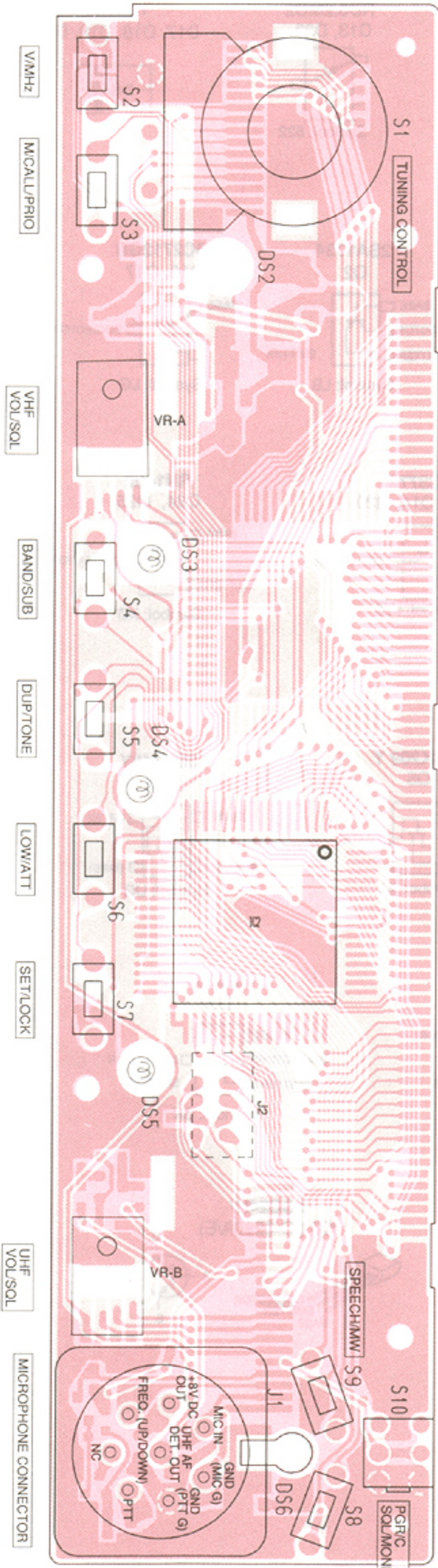

• DISPLAY UNIT (BOTTOM VIEW)

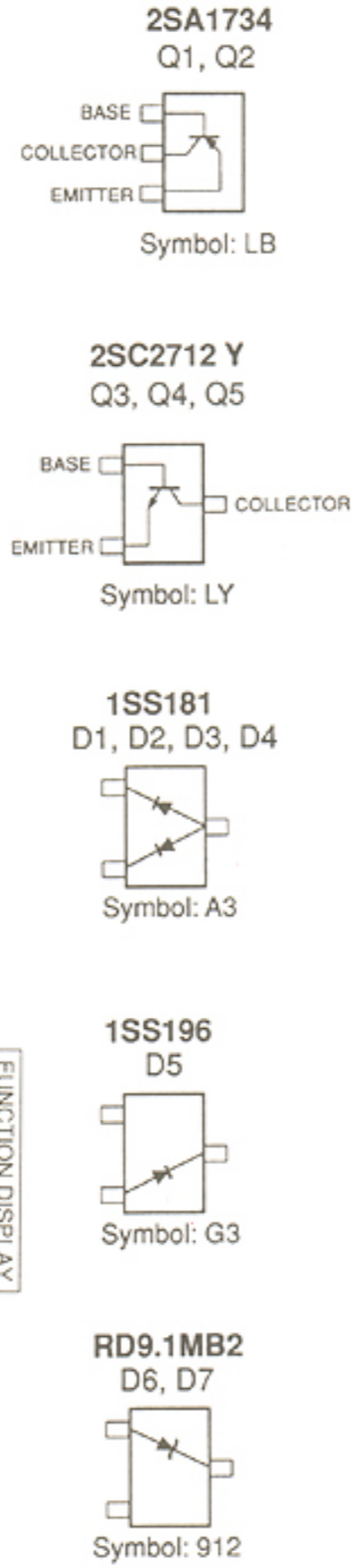

OPTIONAL UNIT

DATA	STBSP
CK	BUSY
E	L5V
VOICE	UNITS

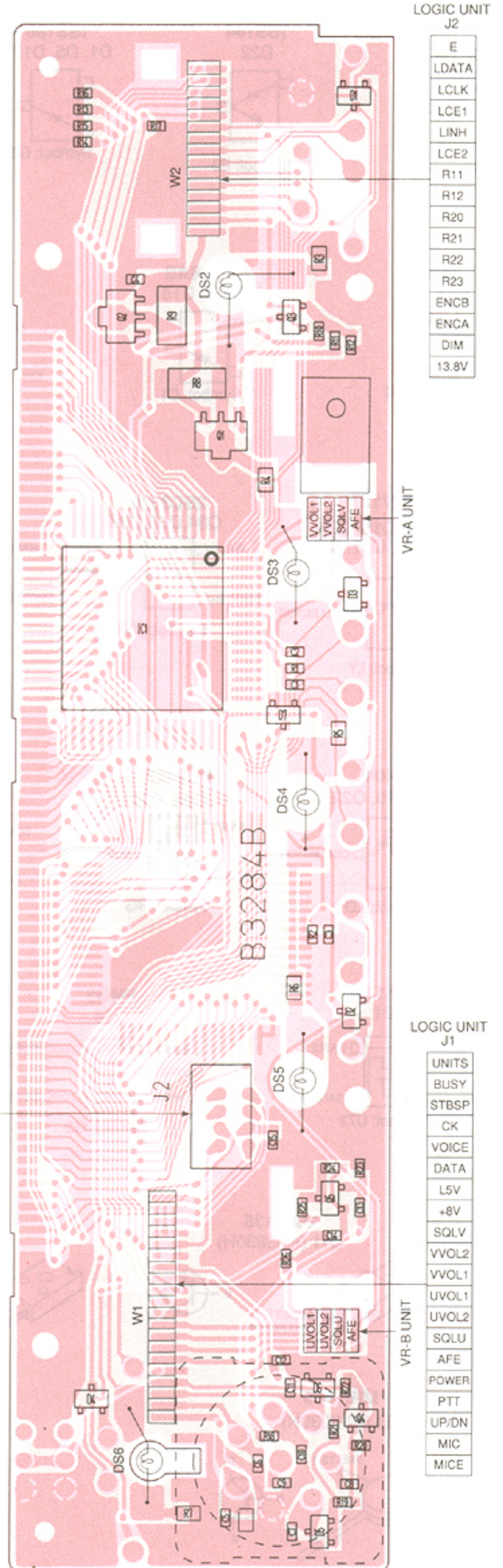

7-3 MAIN-A UNIT AND VCO-A UNIT

• MAIN-A UNIT

1SS153
D3, D4



Symbol: A9

1SS184
D22



Symbol: B3

1SS196
D1, D5, D12



Symbol: G3

1SS226
D11, D14



Symbol: C3

RD6.2MB2
D13, D23



Symbol: 622

1SV166
D17, D18, D19, D20



MA862
D16, D21



Symbol: M11

HSM88AS
D6, D7, D15



Symbol: C1

2SA1162
Q6

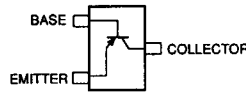

Symbol: SY

2SA1734
Q2

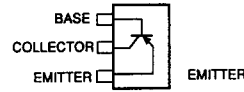

Symbol: LB

2SC2712GR
Q16, Q17

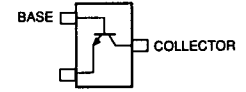

Symbol: LG

2SC2712 Y

Q1, Q12, Q15, Q28,
Q29, Q30, Q31, Q32,
Q33, Q37

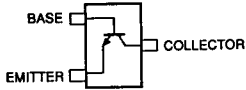

Symbol: LY

2SC3326
Q34, Q35, Q36

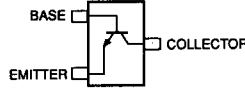

Symbol: CCB

2SC3661
Q3

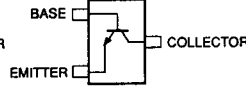

Symbol: FY

2SC3772
Q4, Q7, Q14, Q20

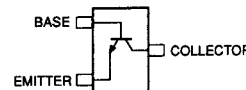

Symbol: LY3

RN1402
Q24, Q25

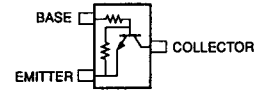

Symbol: XB

RN1404
Q9, Q10, Q22

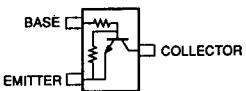

Symbol: XD

RN2427
Q26, Q27

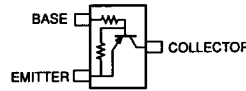

Symbol: RG

2SJ106 Y
Q13

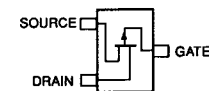

Symbol: VY

2SK209 Y
Q5

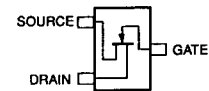

Symbol: XY

3SK140Y
Q19

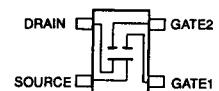

Symbol: UG

3SK177
Q21

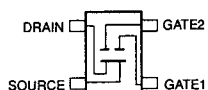

Symbol: U73

FMG2
Q18

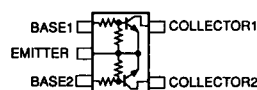

Symbol: G2

IMD6
Q23

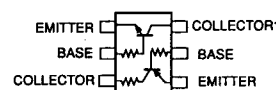

Symbol: D6

2SB798
Q38

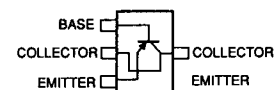

Symbol: DK

2SB1135
Q11 (IC-3230H)

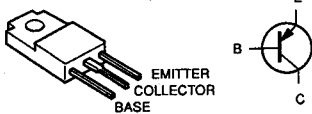

2SB1143
Q11 (IC-3230A/E)

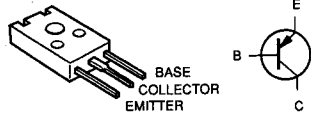

2SC2407
Q8 (IC-3230A/E)

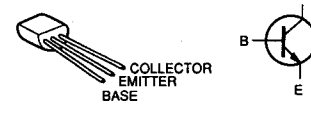

MRF-559
Q8 (IC-3230H)

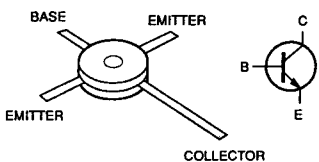

• MAIN-A UNIT (TOP VIEW)

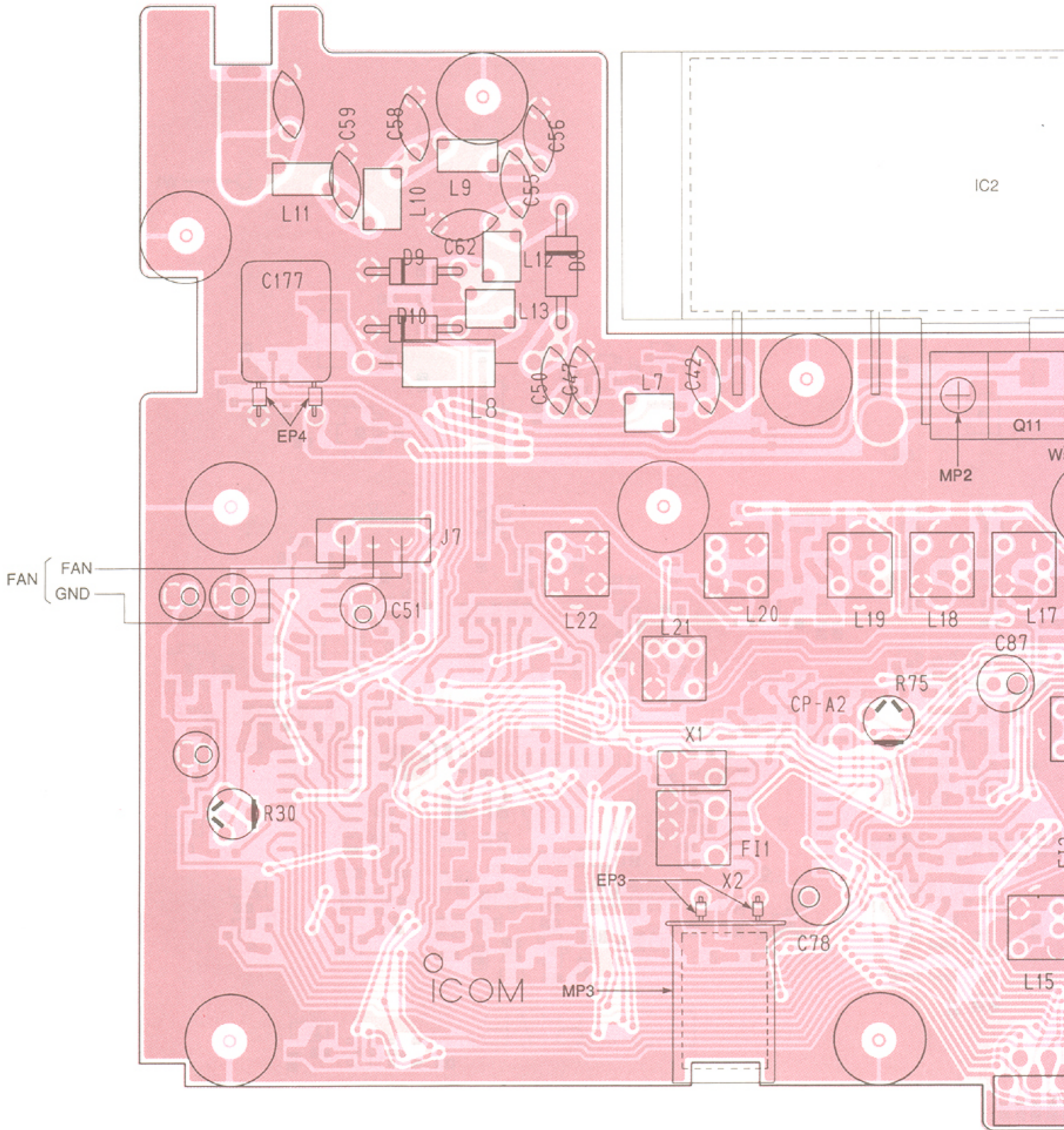

STBCOM	STBVHF	VOICE
DET		DTMF

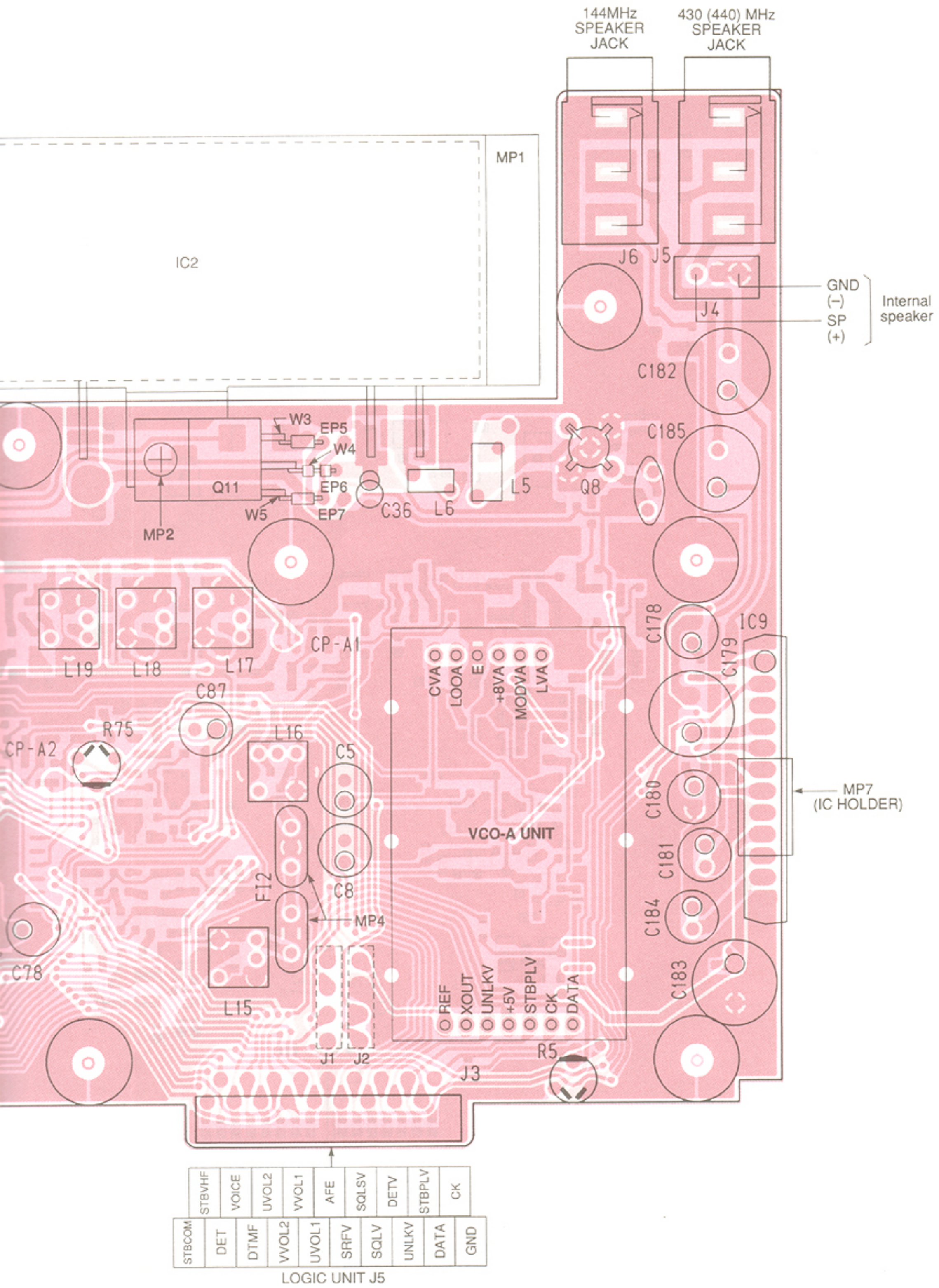

The combination of this page and the next page shows the unit layout in the same configuration as the actual P.C. Board.

• VCO-A UNIT (TOP VIEW)

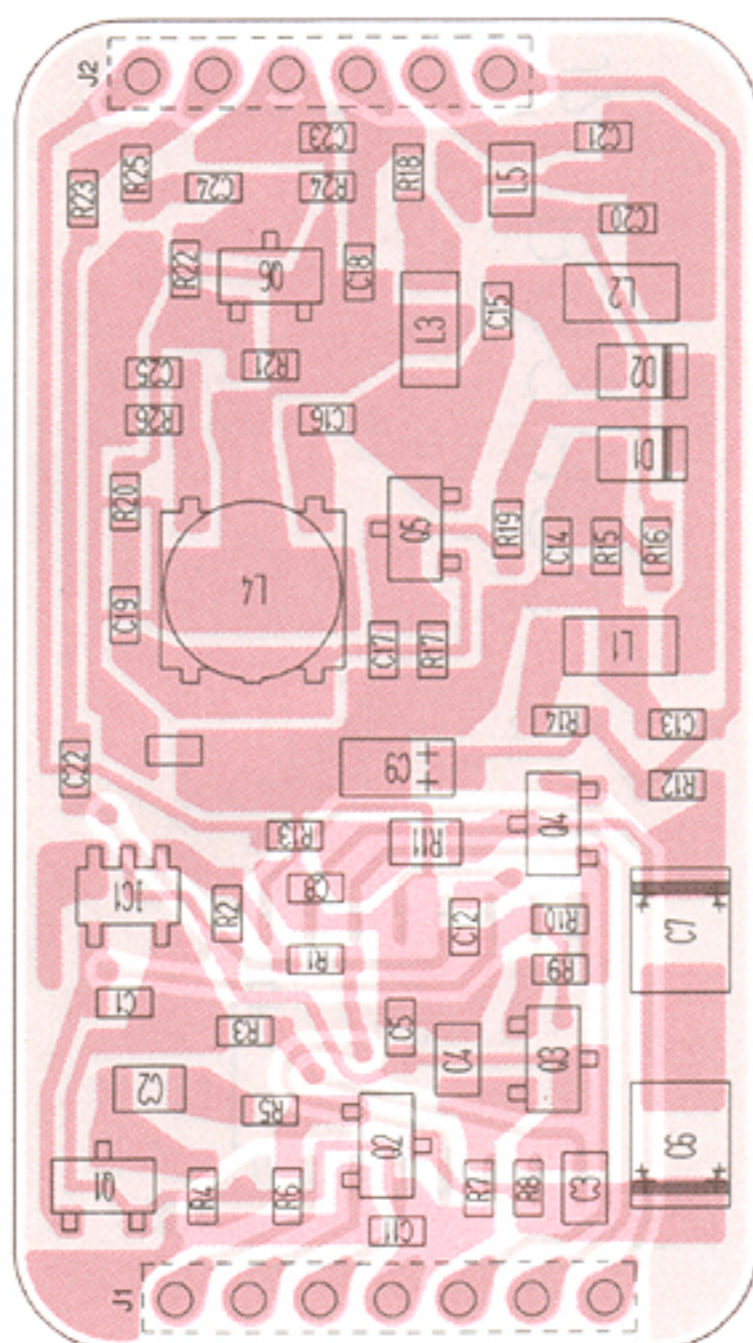

• VCO-A UNIT (BOTTOM VIEW)

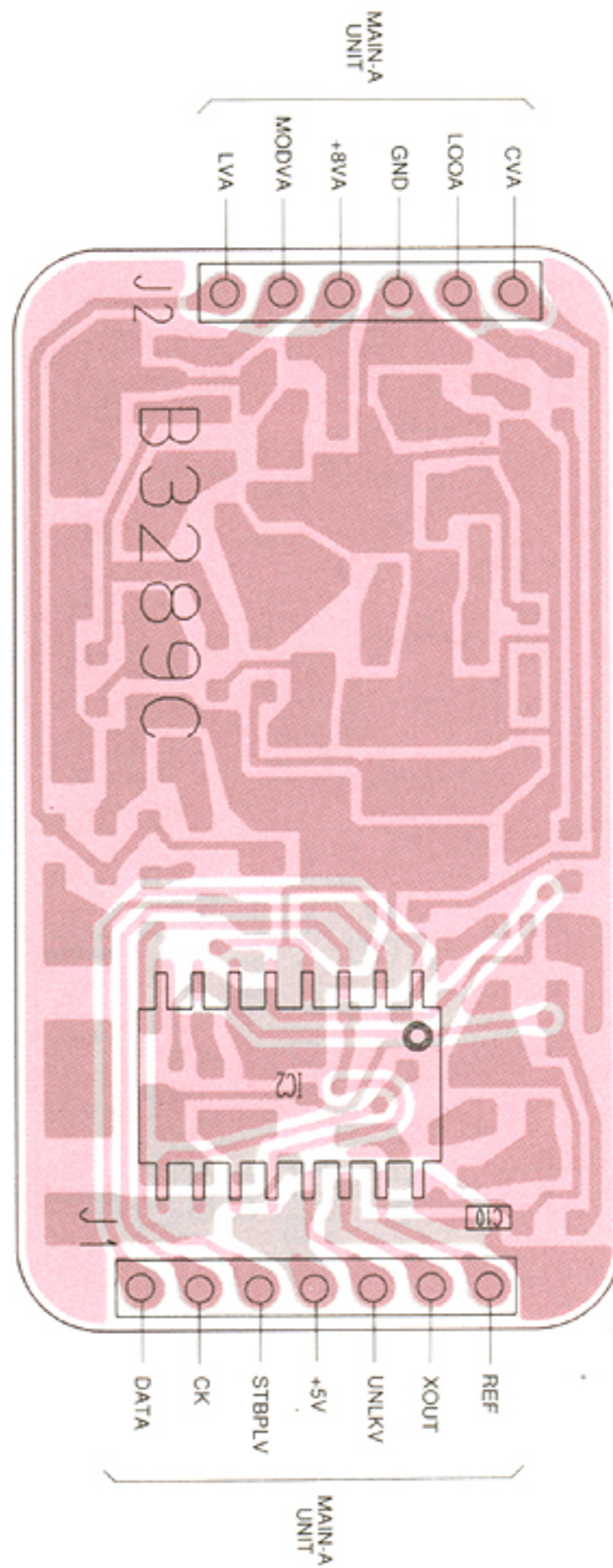

• MAIN-A UNIT (BOTTOM VIEW)

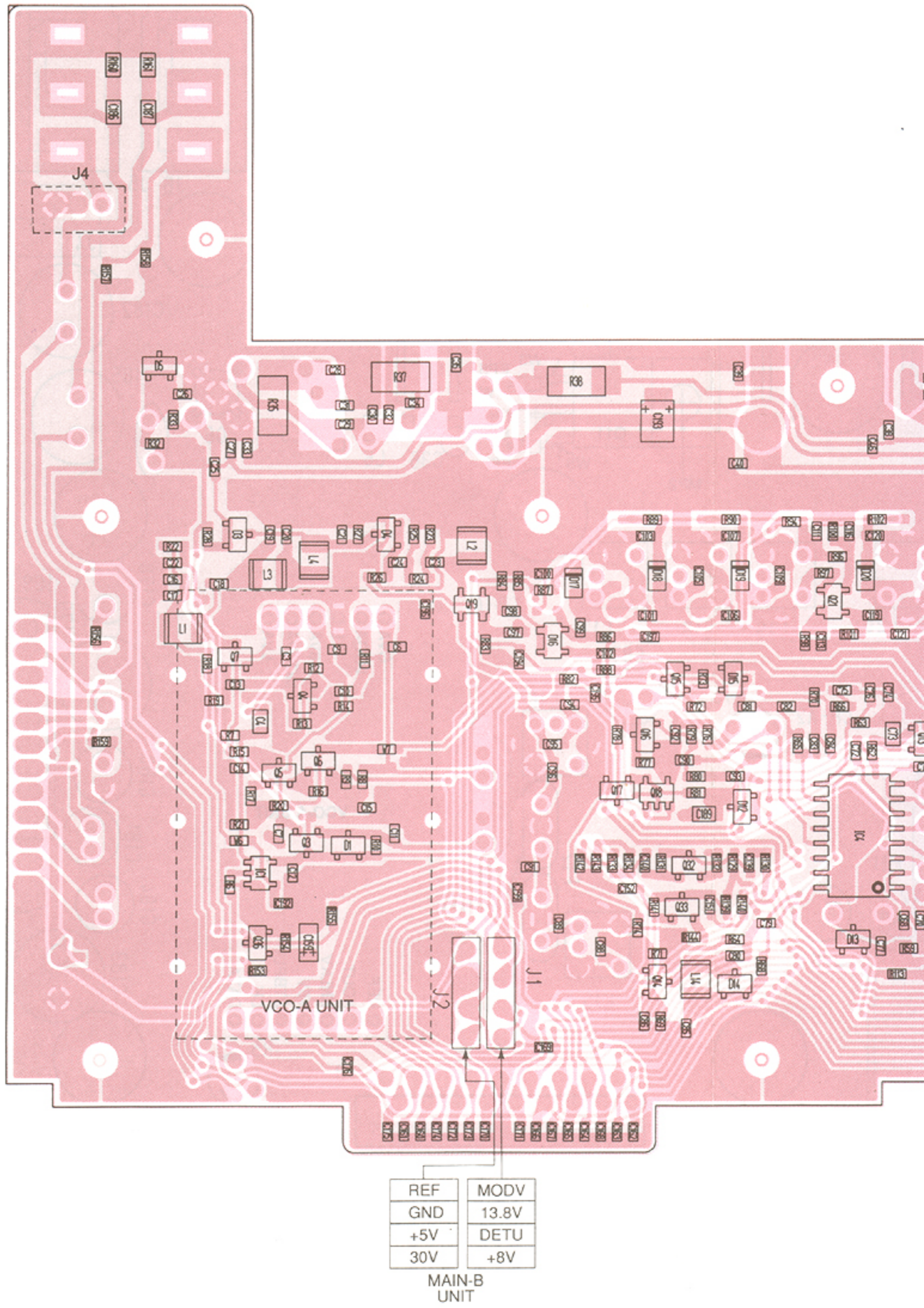

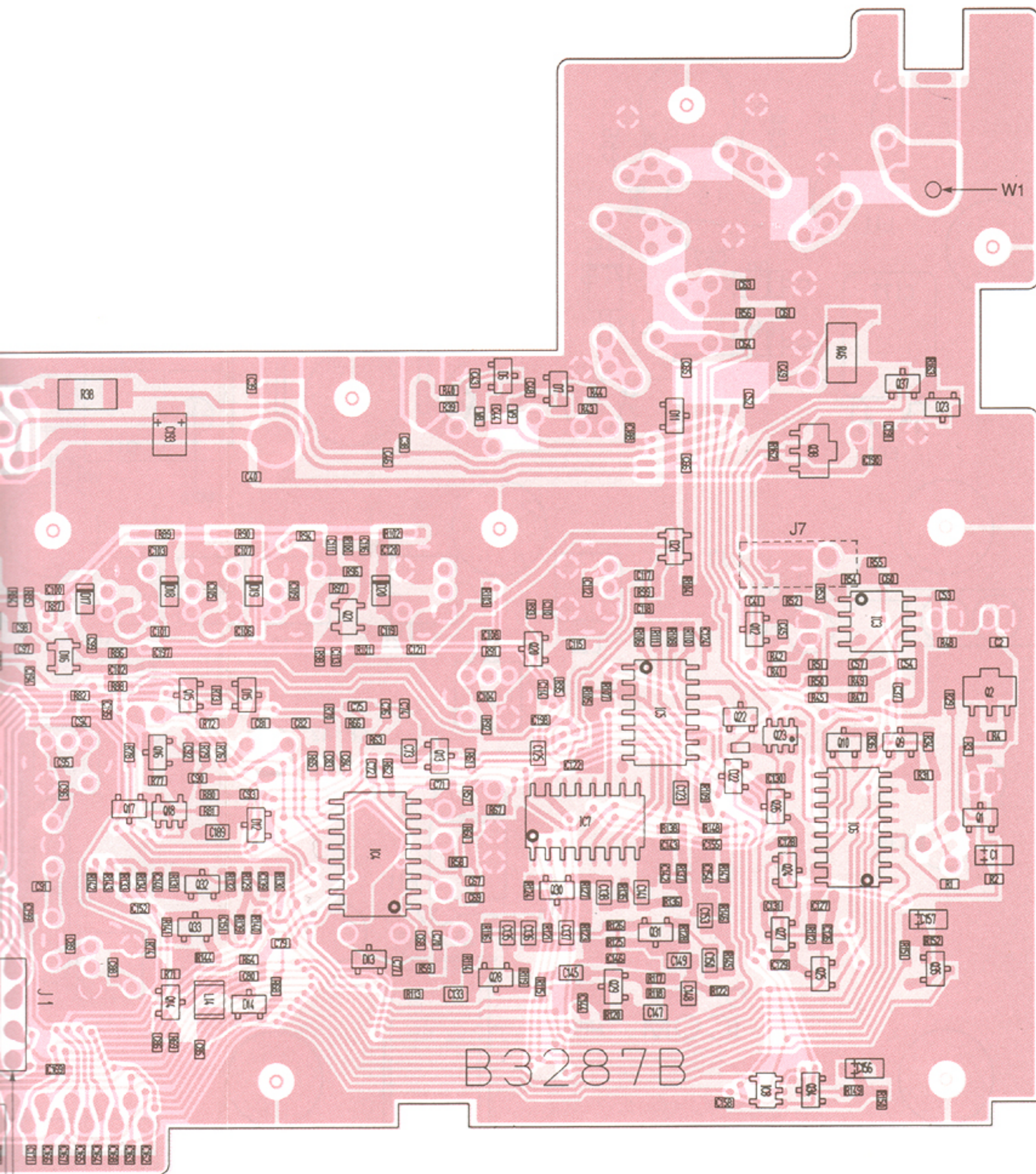

MODV
 3.8V
 METU
 +8V

7-4 MAIN-B UNIT, VCO-B AND B-BAND UNITS

• MAIN-B UNIT (TOP VIEW)

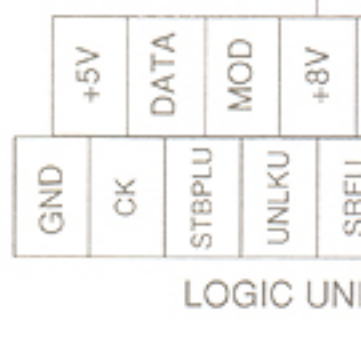
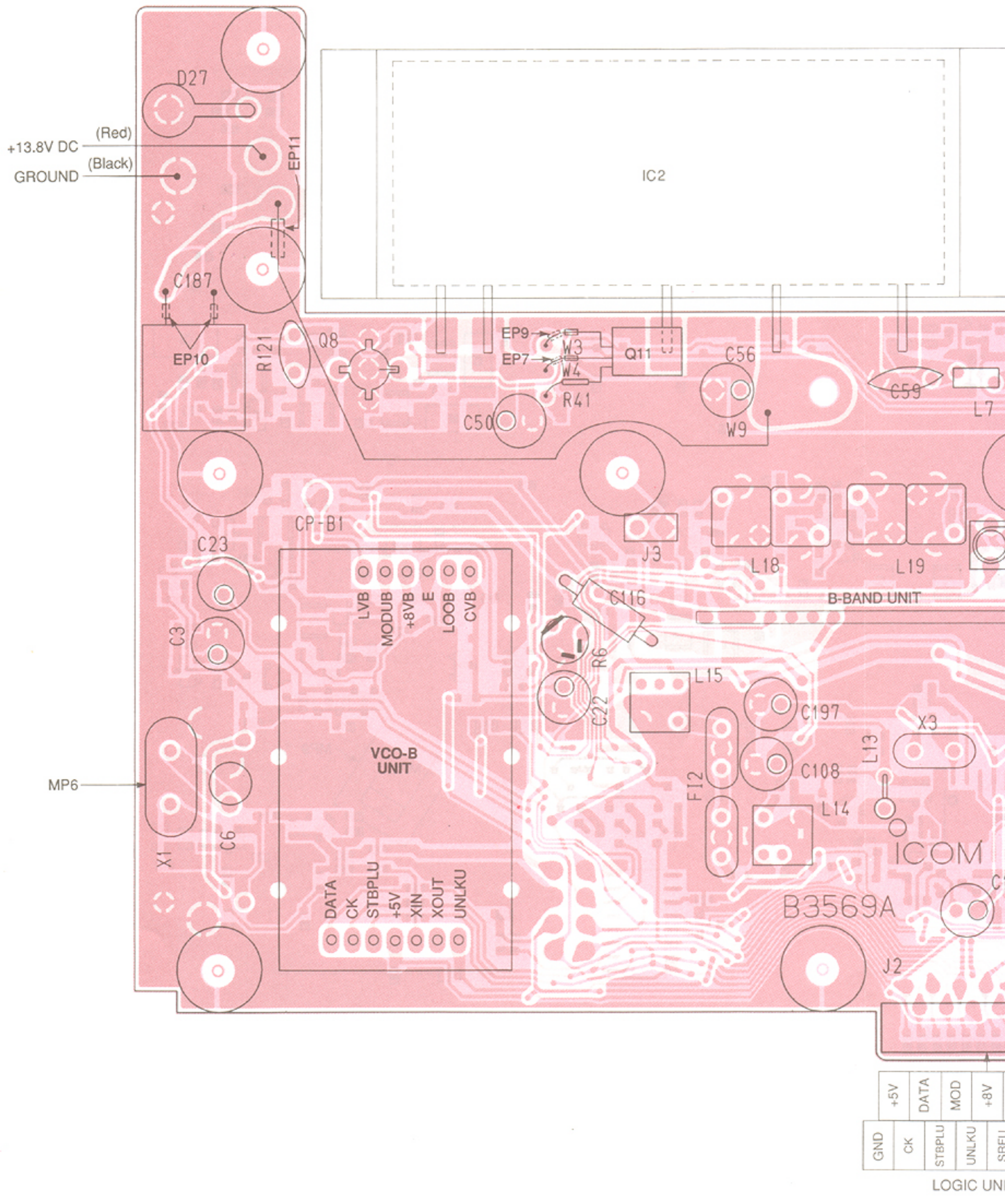

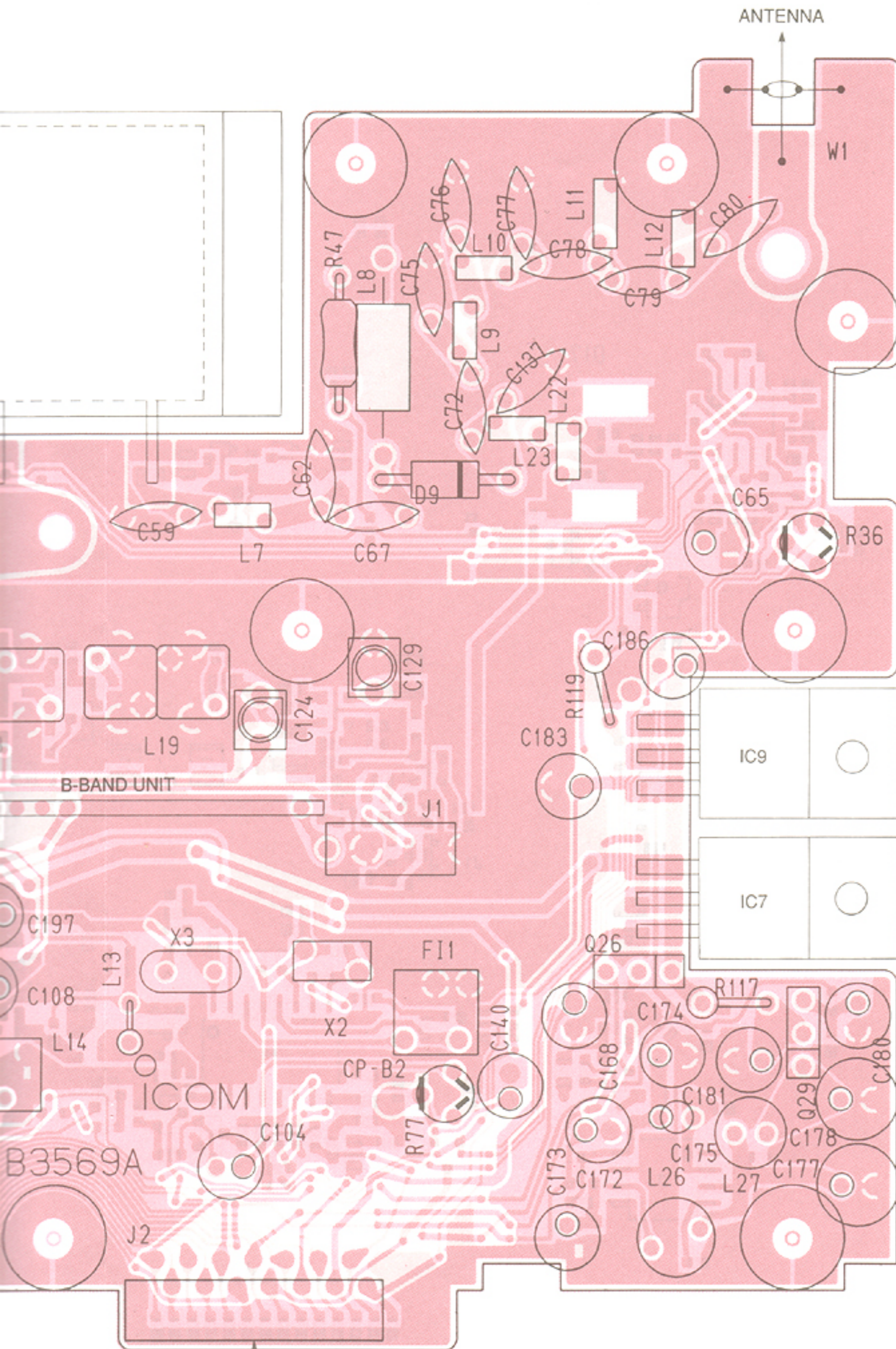

GND	+5V	DATA	MOD	+8V	STBUHF	SQLSU	SQLU
CK	STBPLU	UNLKU	SRFU	DETU	13.8V	POWER	

LOGIC UNIT J6

The combination of this page and the next page shows the unit layout in the same configuration as the actual P.C. Board.

• B-BAND UNIT (TOP VIEW)

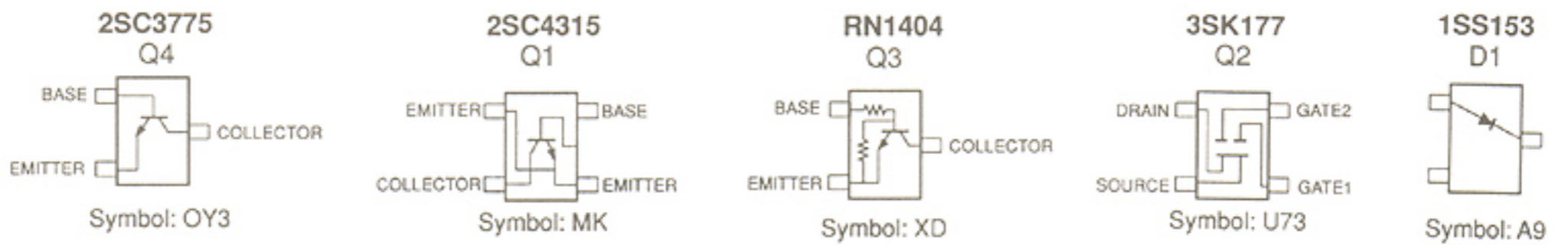
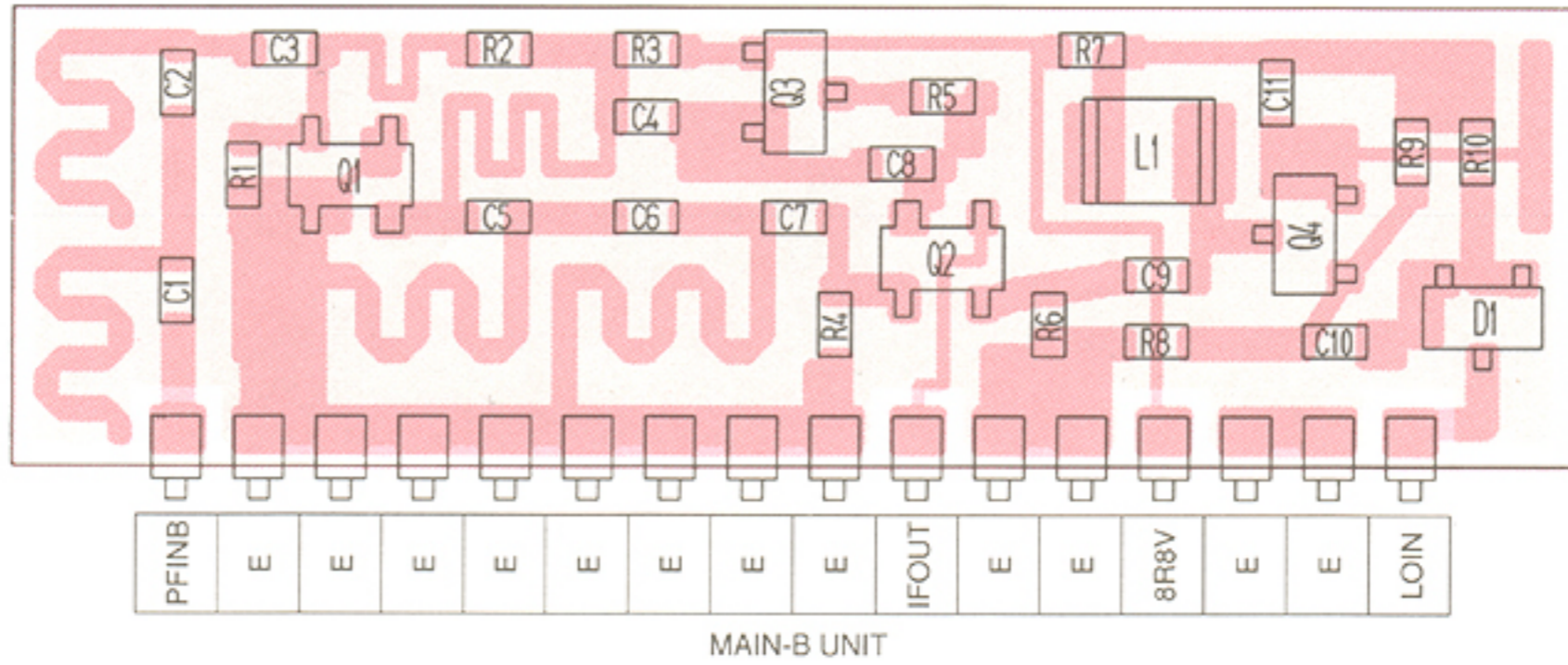

• VCO-B UNIT (TOP VIEW)

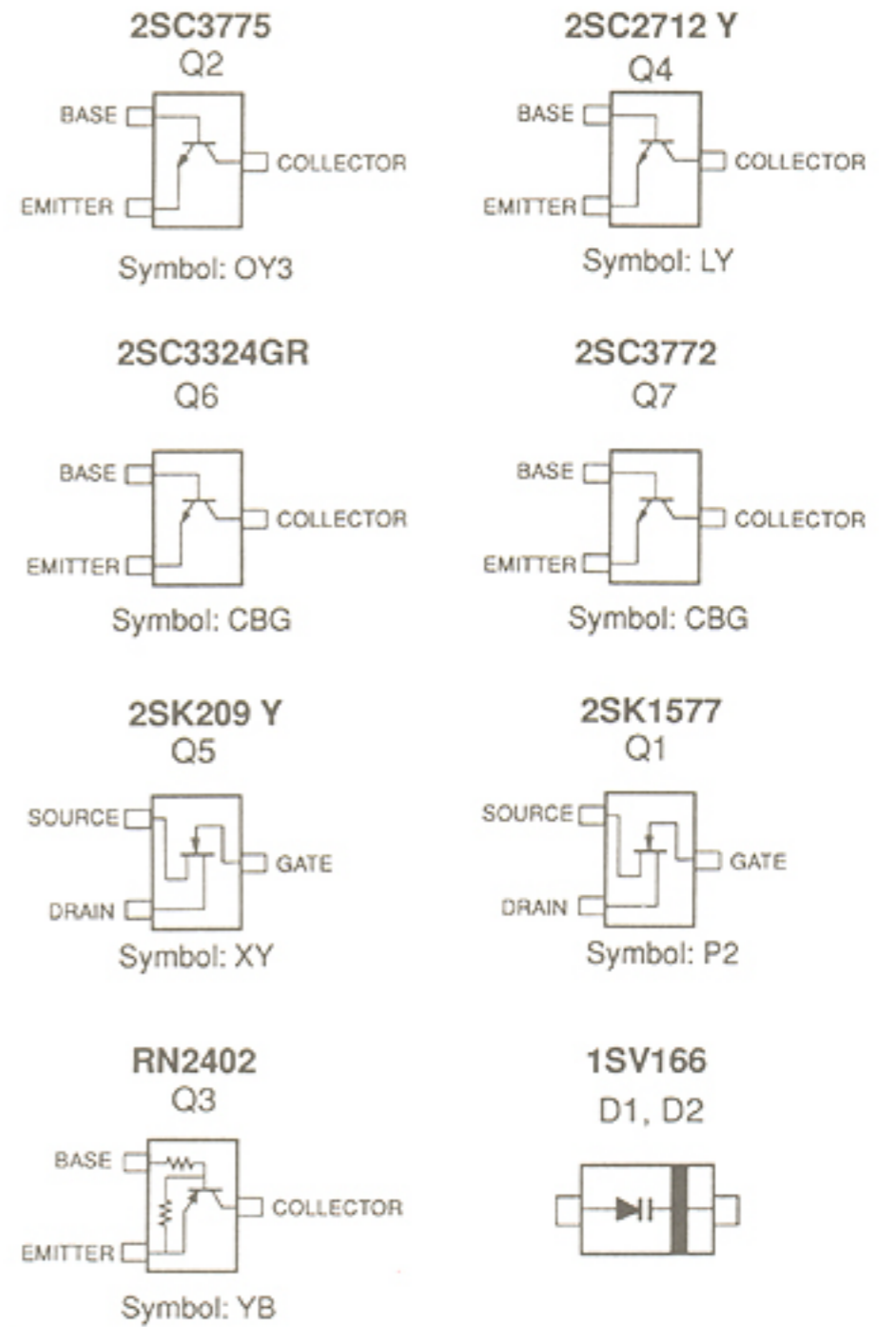
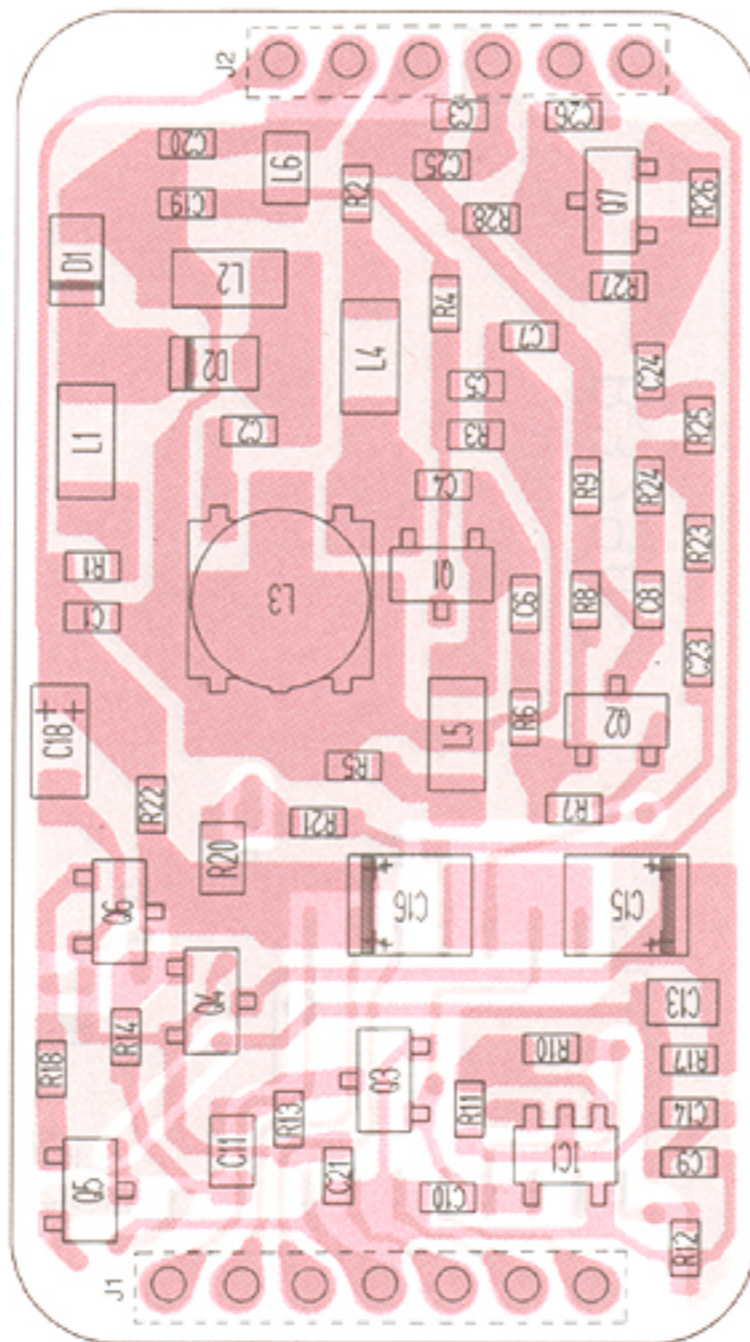

• VCO-B UNIT (BOTTOM VIEW)

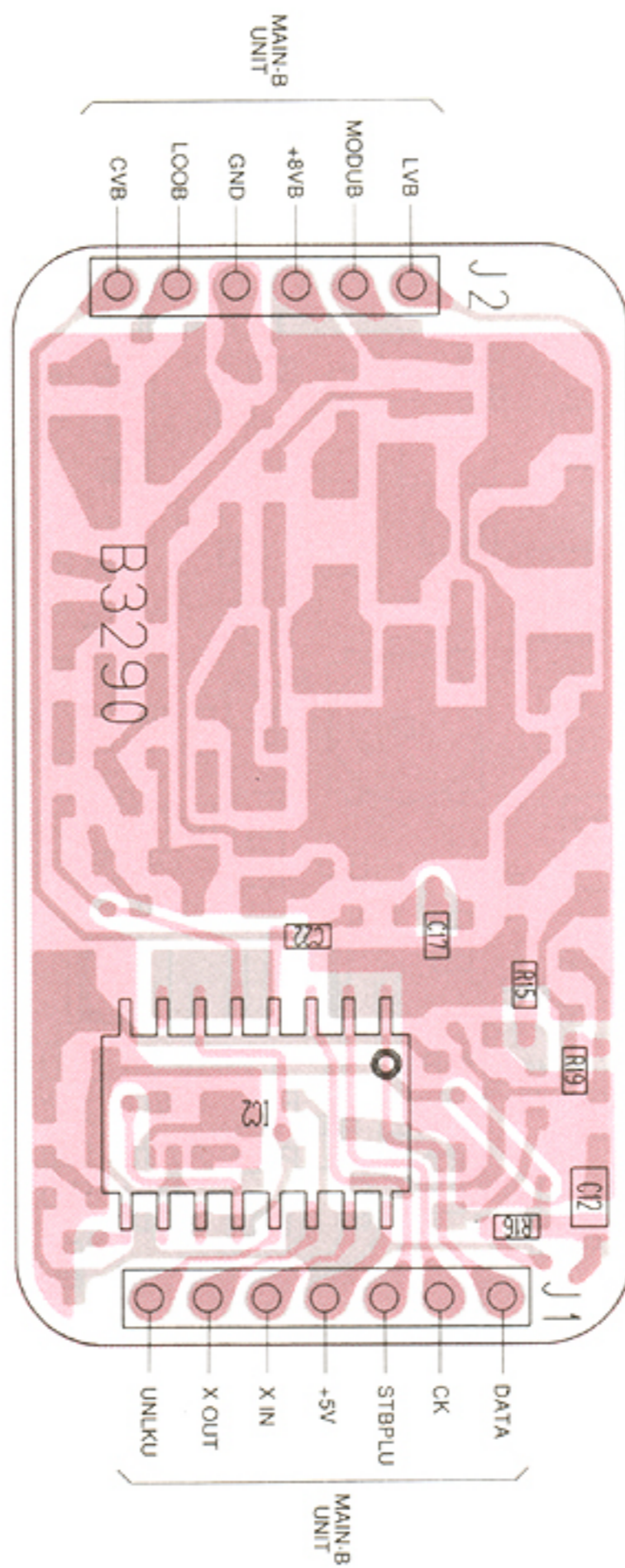

• MAIN-B UNIT (BOTTOM VIEW)

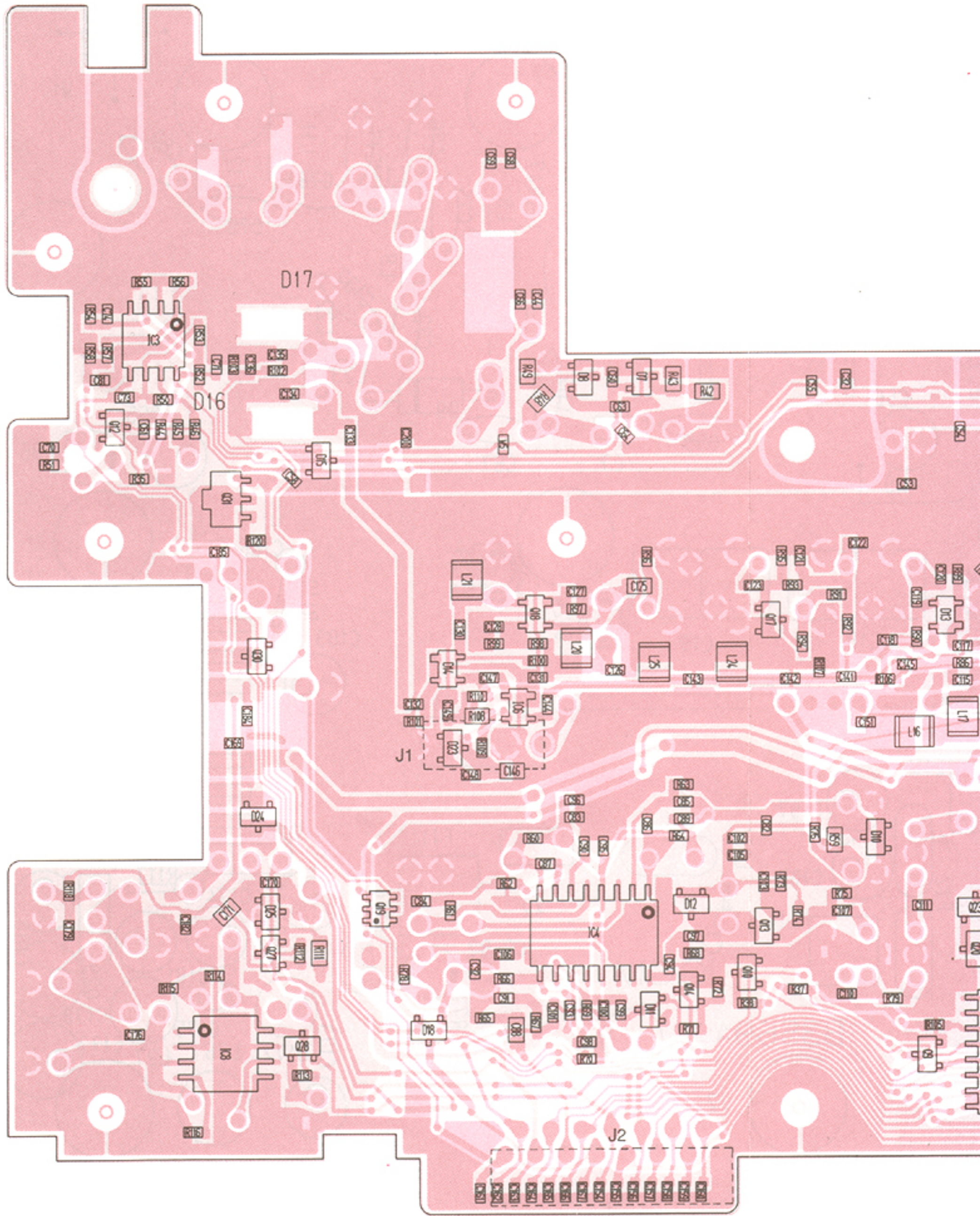

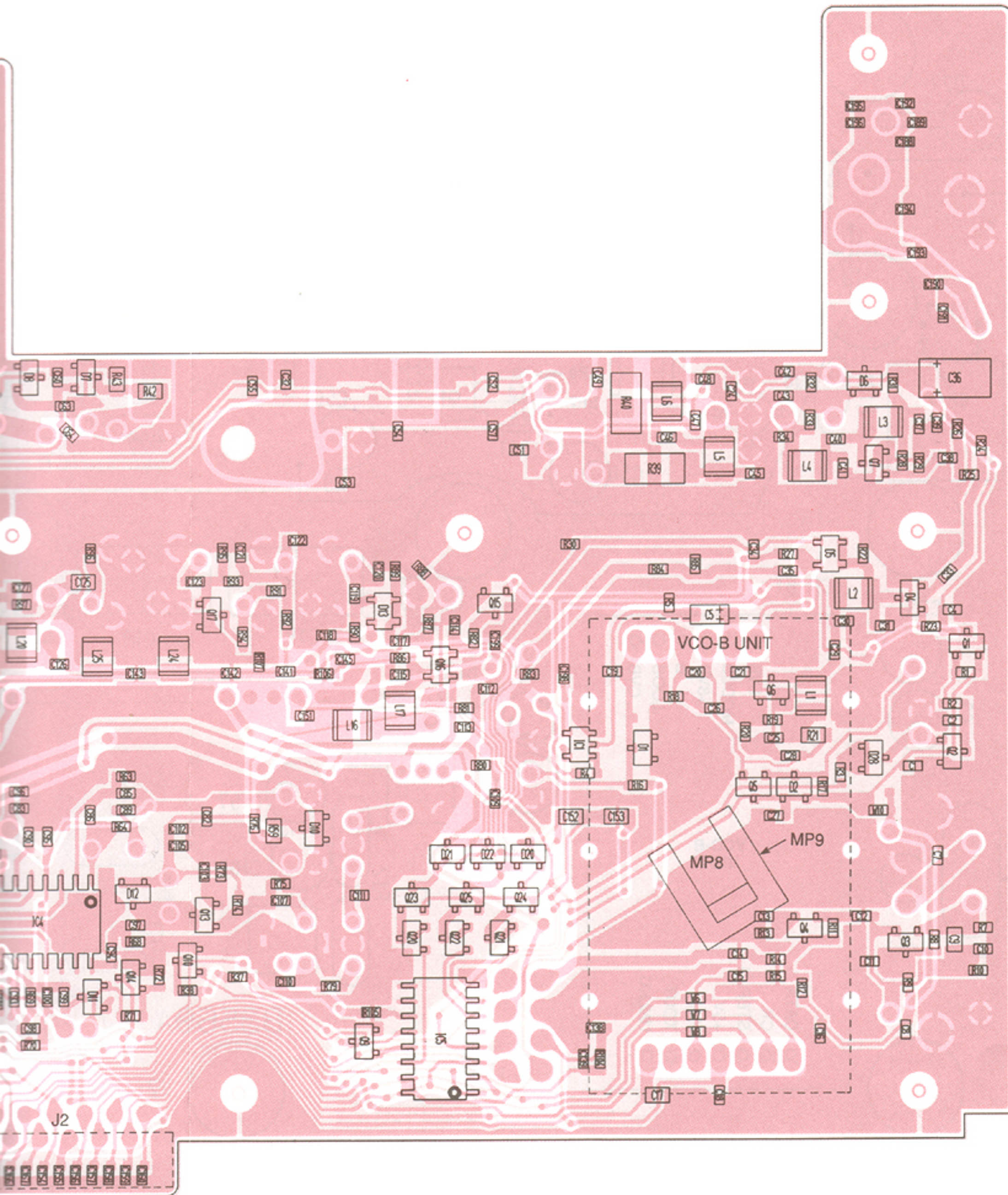

• MAIN-B UNIT

1SS153
D4



Symbol: A9

1SS184
D18, D20, D21



Symbol: B3

1SS196
D2, D6, D22,
D24, D25, D28



Symbol: G3

1SS226
D12, D15



Symbol: C3

RD4.3MB1
D23



Symbol: 431

RD6.2MB2
D10



Symbol: 622

RD24M B2
D1



Symbol: 242

MA862
D5, D13, D14



Symbol: MI1

HSM88AS
D7, D8, D11



Symbol: C1

2SA1362GR
Q1

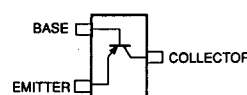

Symbol: AEG

2SA1736
Q31

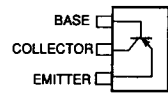

Symbol: LD

2SC2712BL
Q28

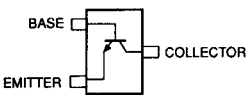

Symbol: LL

2SC2712 Y
Q2, Q3, Q12, Q14, Q27

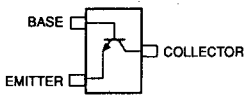

Symbol: LY

2SC1714 Y
Q4

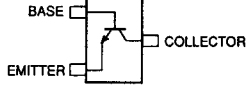

Symbol: QY

2SC3661
Q5

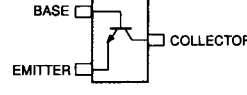

Symbol: FY

2SC3770
Q13

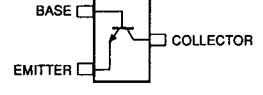

Symbol: JY3

2SC3775
Q6, Q7, Q17

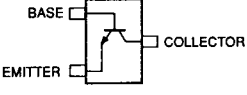

Symbol: OY3

RN1402
Q20, Q21, Q22

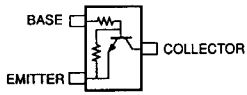

Symbol: XB

RN1404
Q9, Q10, Q15

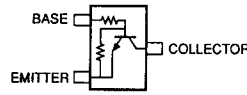

Symbol: XD

RN2427
Q30

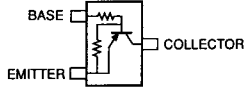

Symbol: RG

3SK140Y
Q16

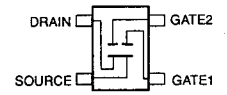

Symbol: UG

3SK177
Q18

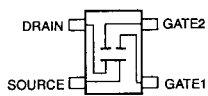

Symbol: U73 U74

IMD6
Q19

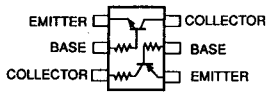

Symbol: D6

DTB123EK
Q23, Q24, Q25

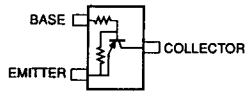

Symbol: F12

2SB909M
Q26

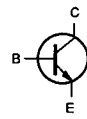

MRF-559
Q8

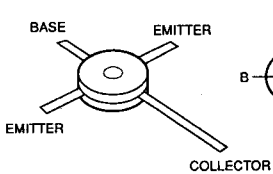

Symbol: 559

2SB1143
Q11

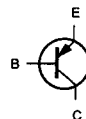
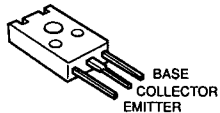

SECTION 8 BLOCK DIAGRAM

DISPLAY UNIT

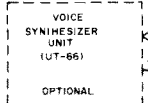
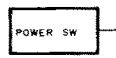
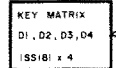
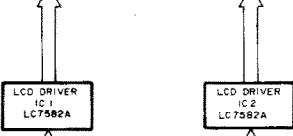
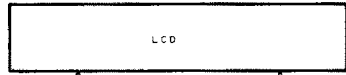

VR-A UNIT

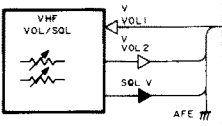

VR-B UNIT

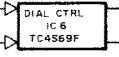
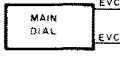
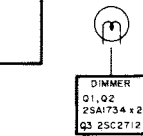
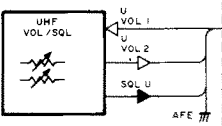

LOGIC UNIT

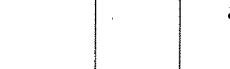
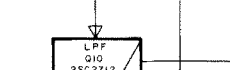
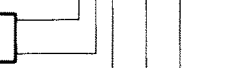
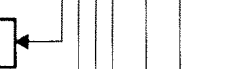
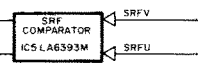
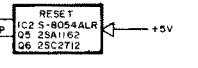
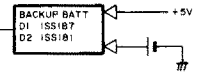
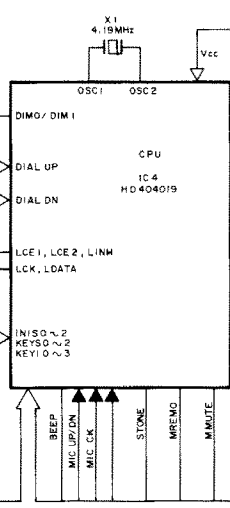

TONE UNIT

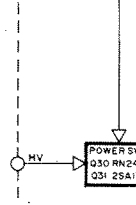
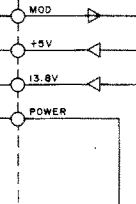
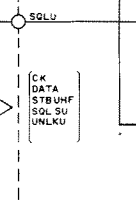
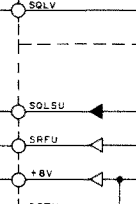
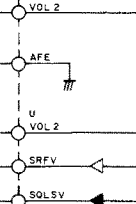
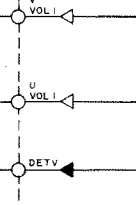
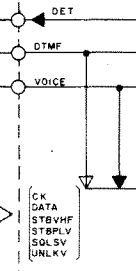
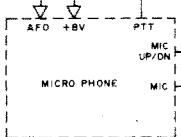
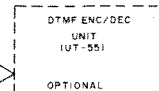
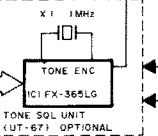

MAIN-A UNIT

VCO-A UNIT

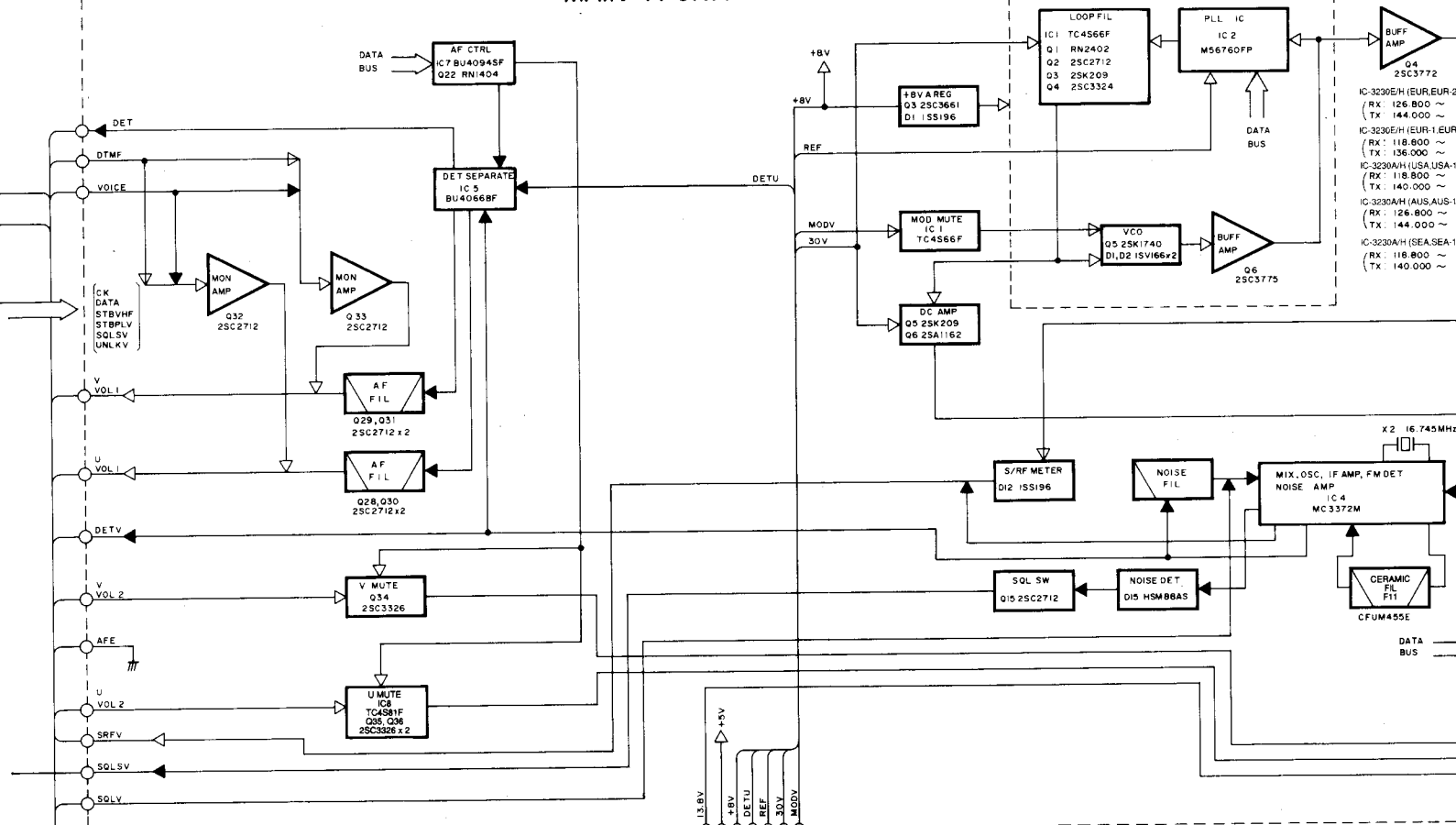

MAIN-B UNIT

VCO-B UNIT

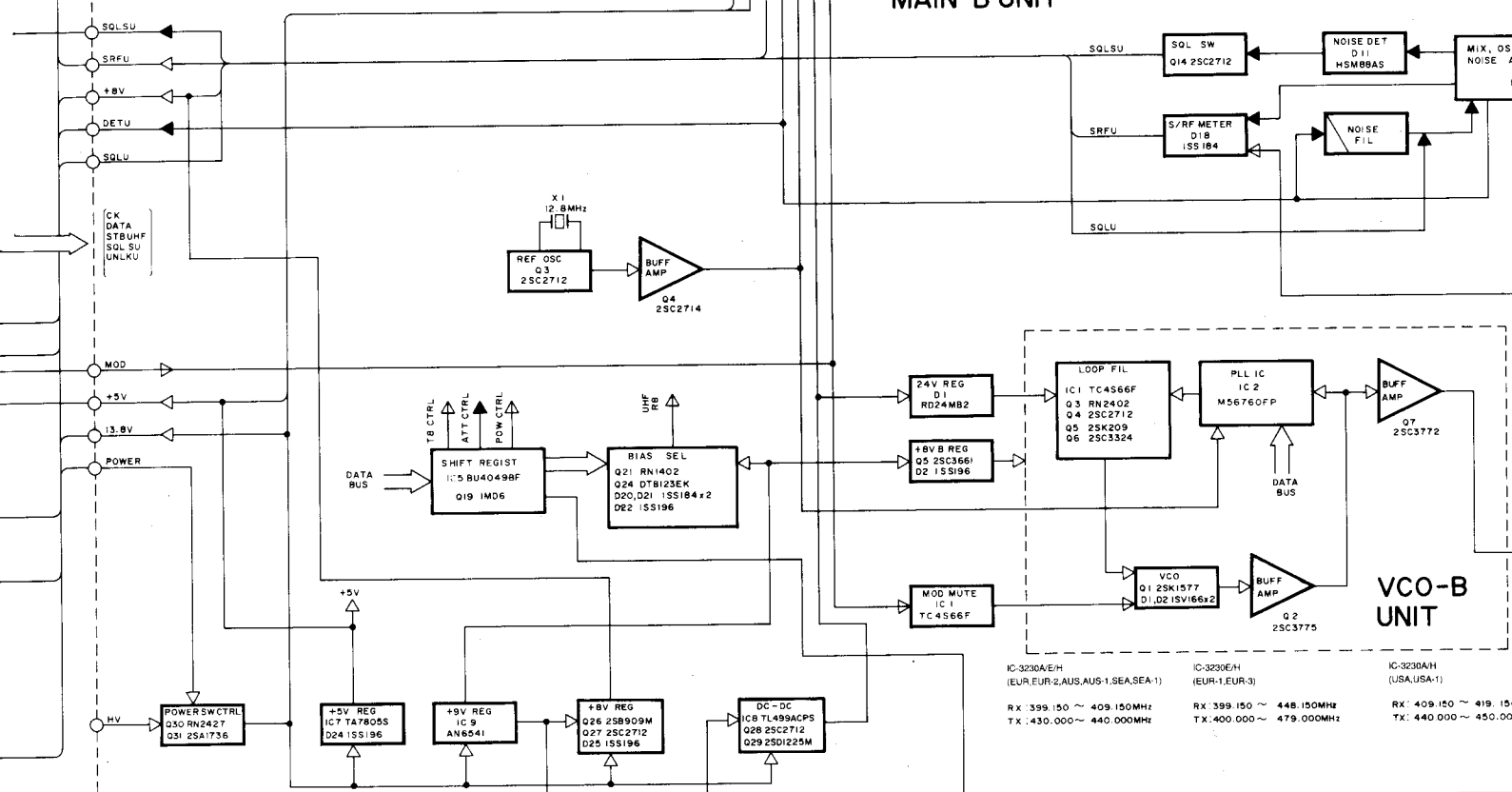

IC-3230A/E/H (EUR, EUR-2, AUS, AUS-1, SEA, SEA-1) RX: 399.150 ~ 409.150MHz TX: 430.000 ~ 440.000MHz

IC-3230E/H (EUR-1, EUR-3) RX: 399.150 ~ 448.150MHz TX: 400.000 ~ 479.000MHz

IC-3230A/H (USA, USA-1) RX: 409.150 ~ 419.150MHz TX: 440.000 ~ 450.000MHz

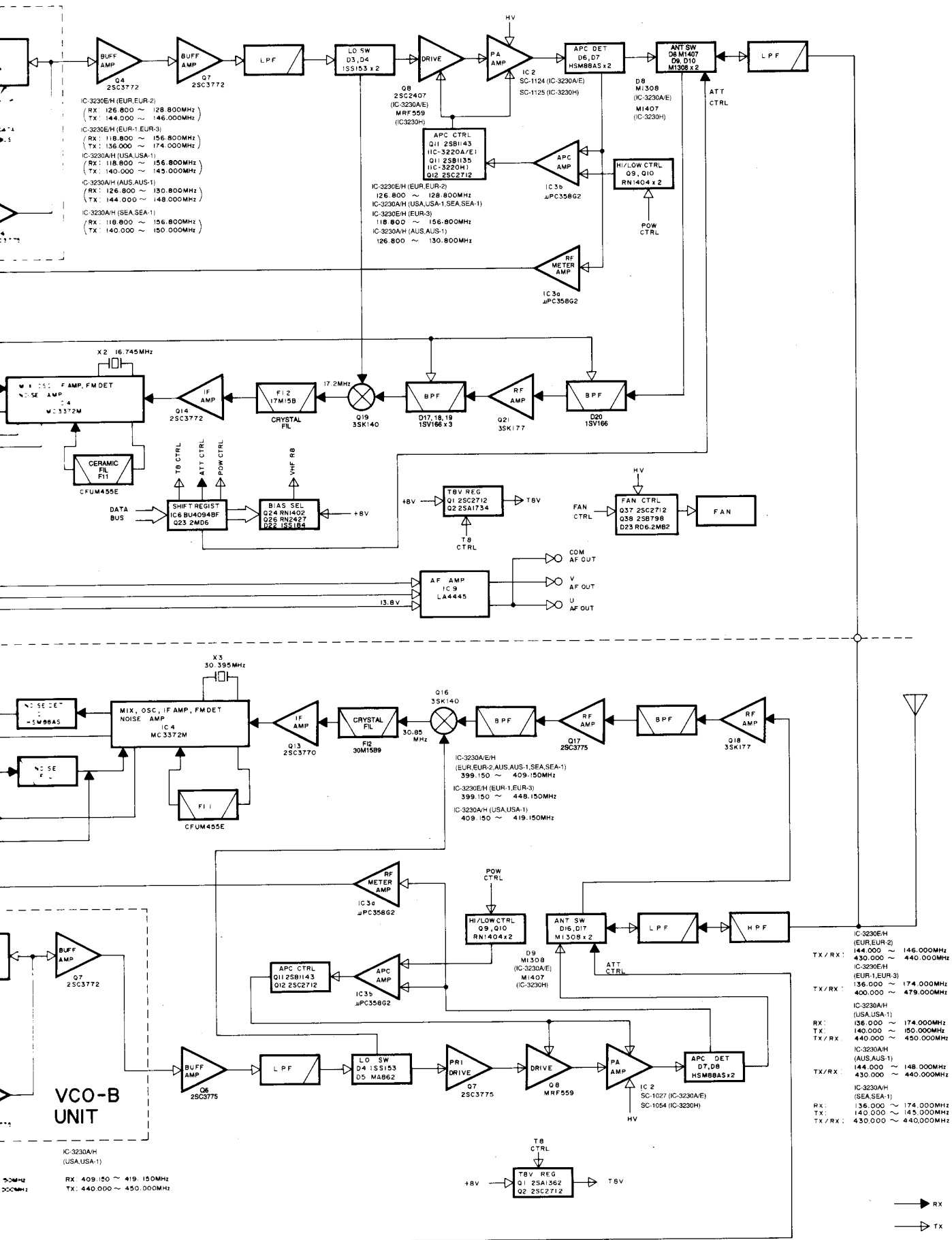

IC-3230E/H (EUR, EUR-2)
 (RX: 126.800 ~ 128.800MHz)
 (TX: 144.000 ~ 146.000MHz)

IC-3230E/H (EUR-1, EUR-3)
 (RX: 118.800 ~ 156.800MHz)
 (TX: 136.000 ~ 174.000MHz)

IC-3230A/H (USA, USA-1)
 (RX: 118.800 ~ 156.800MHz)
 (TX: 140.000 ~ 145.000MHz)

IC-3230A/H (AUS, AUS-1)
 (RX: 126.800 ~ 130.800MHz)
 (TX: 144.000 ~ 148.000MHz)

IC-3230A/H (SEA, SEA-1)
 (RX: 118.800 ~ 156.800MHz)
 (TX: 140.000 ~ 150.000MHz)

IC-3230E/H (EUR, EUR-2)
 126.800 ~ 128.800MHz

IC-3230A/H (USA, USA-1, SEA, SEA-1)
 118.800 ~ 156.800MHz

IC-3230A/H (AUS, AUS-1)
 126.800 ~ 130.800MHz

IC-3230E/H (EUR, EUR-2)
 144.000 ~ 146.000MHz
 430.000 ~ 440.000MHz

IC-3230E/H (EUR-1, EUR-3)
 136.000 ~ 174.000MHz
 400.000 ~ 479.000MHz

IC-3230A/H (USA, USA-1)
 136.000 ~ 174.000MHz
 140.000 ~ 150.000MHz
 440.000 ~ 450.000MHz

IC-3230A/H (AUS, AUS-1)
 144.000 ~ 148.000MHz
 430.000 ~ 440.000MHz

IC-3230A/H (SEA, SEA-1)
 136.000 ~ 174.000MHz
 140.000 ~ 145.000MHz
 430.000 ~ 440.000MHz

VCO-B UNIT

IC-3230A/H (USA, USA-1)
 RX: 409.150 ~ 419.150MHz
 TX: 440.000 ~ 450.000MHz

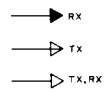

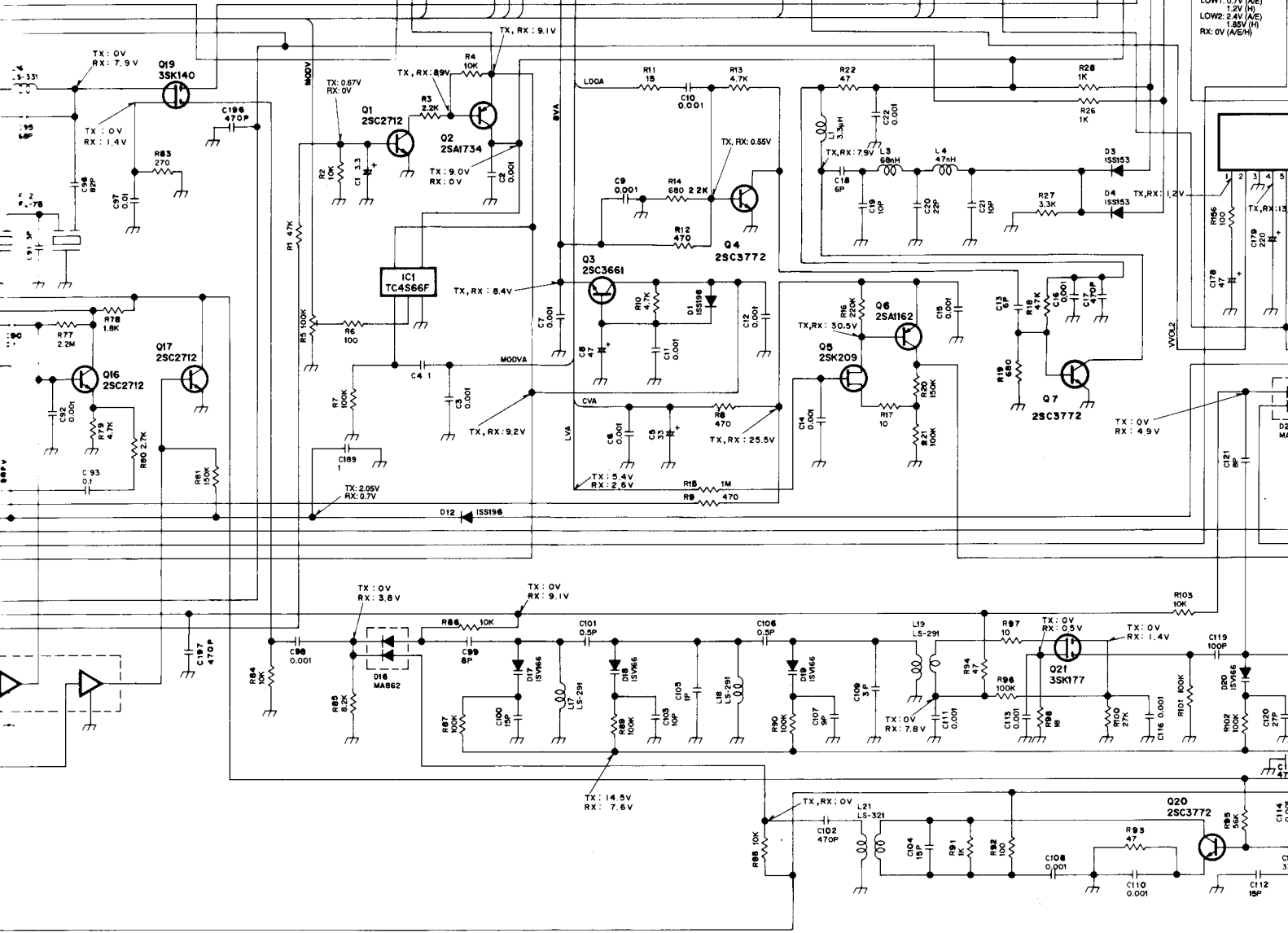
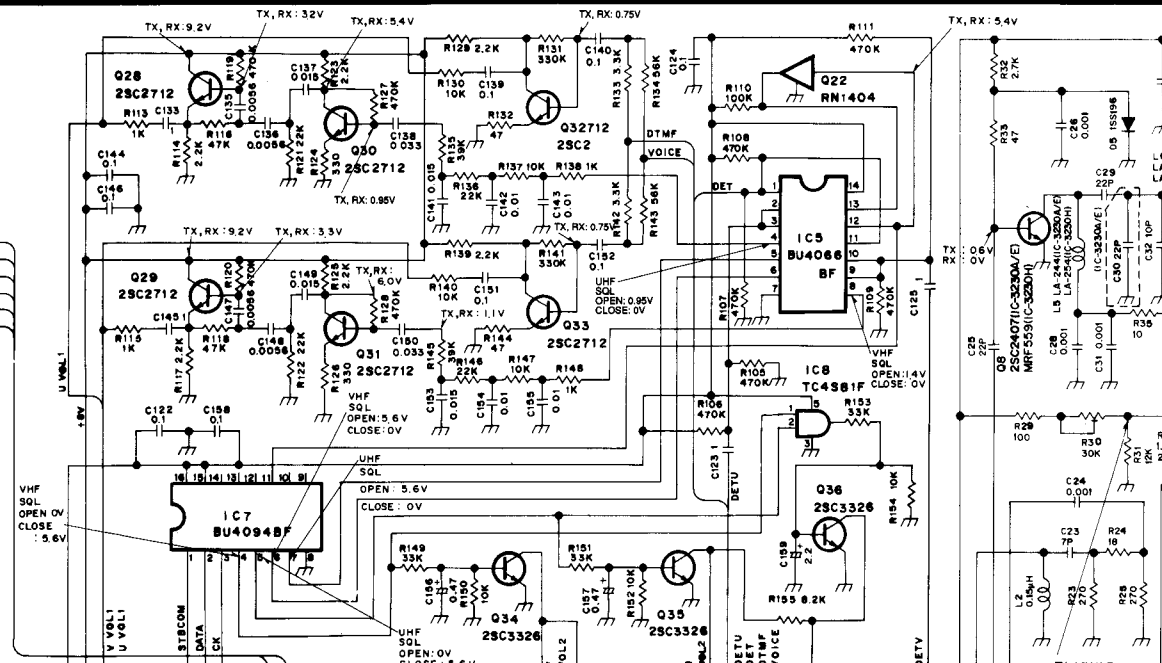
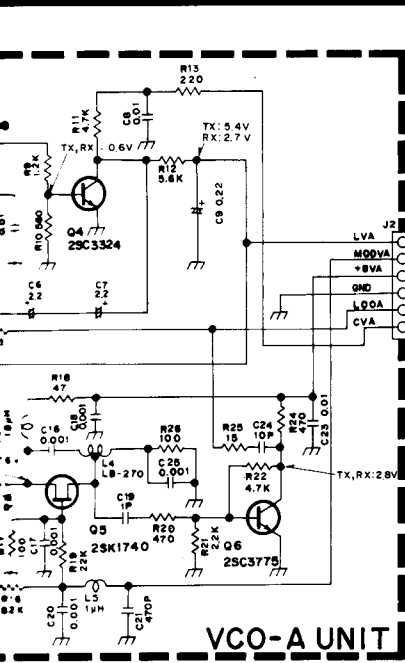

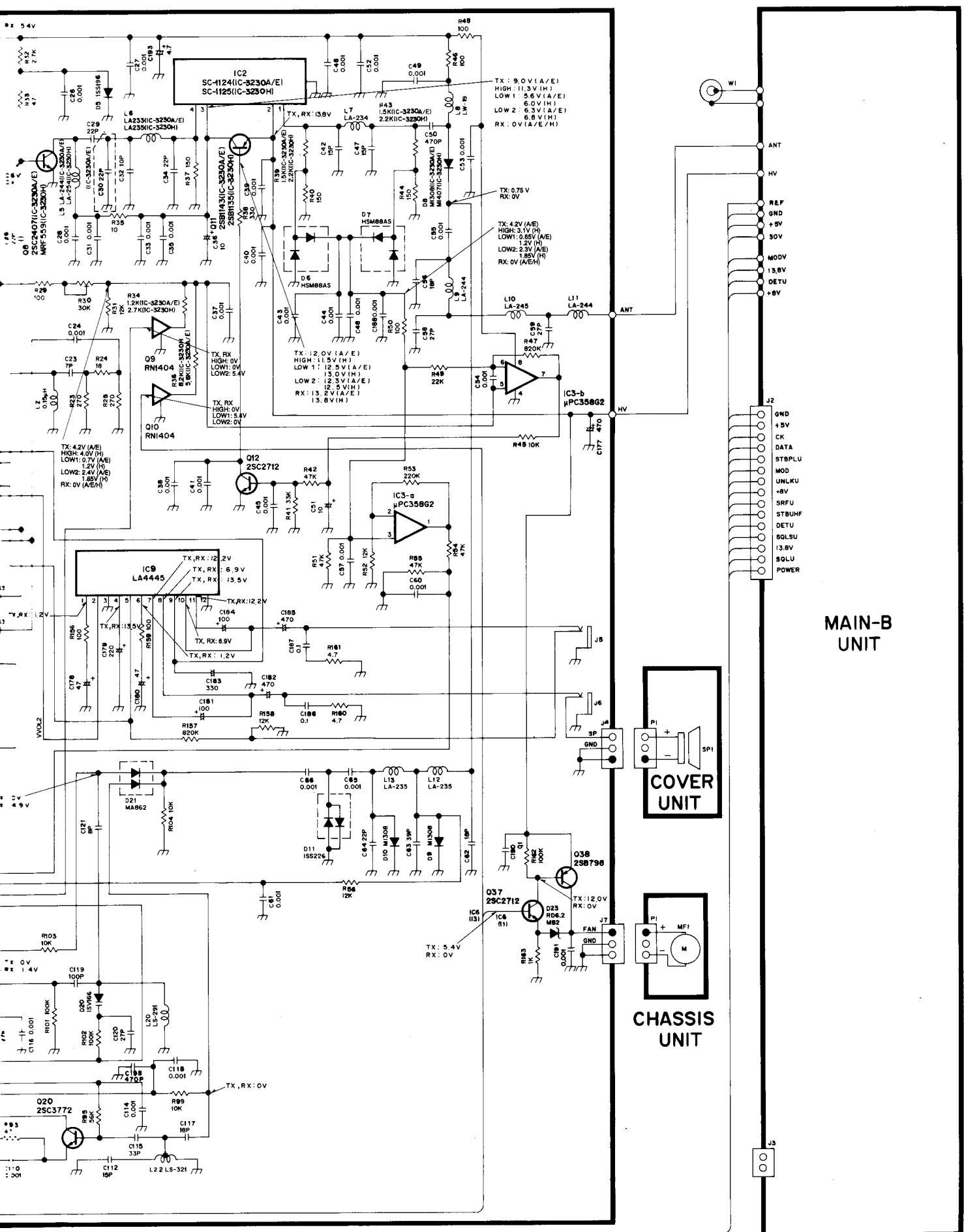

MAIN-B UNIT

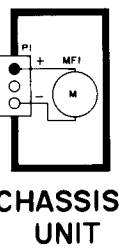
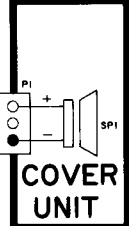

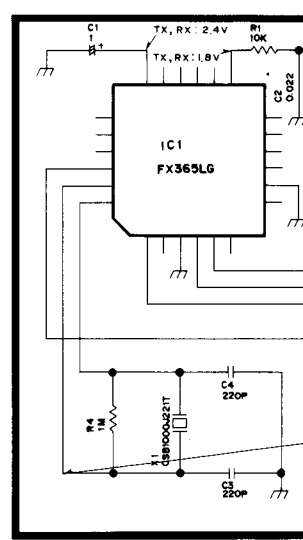
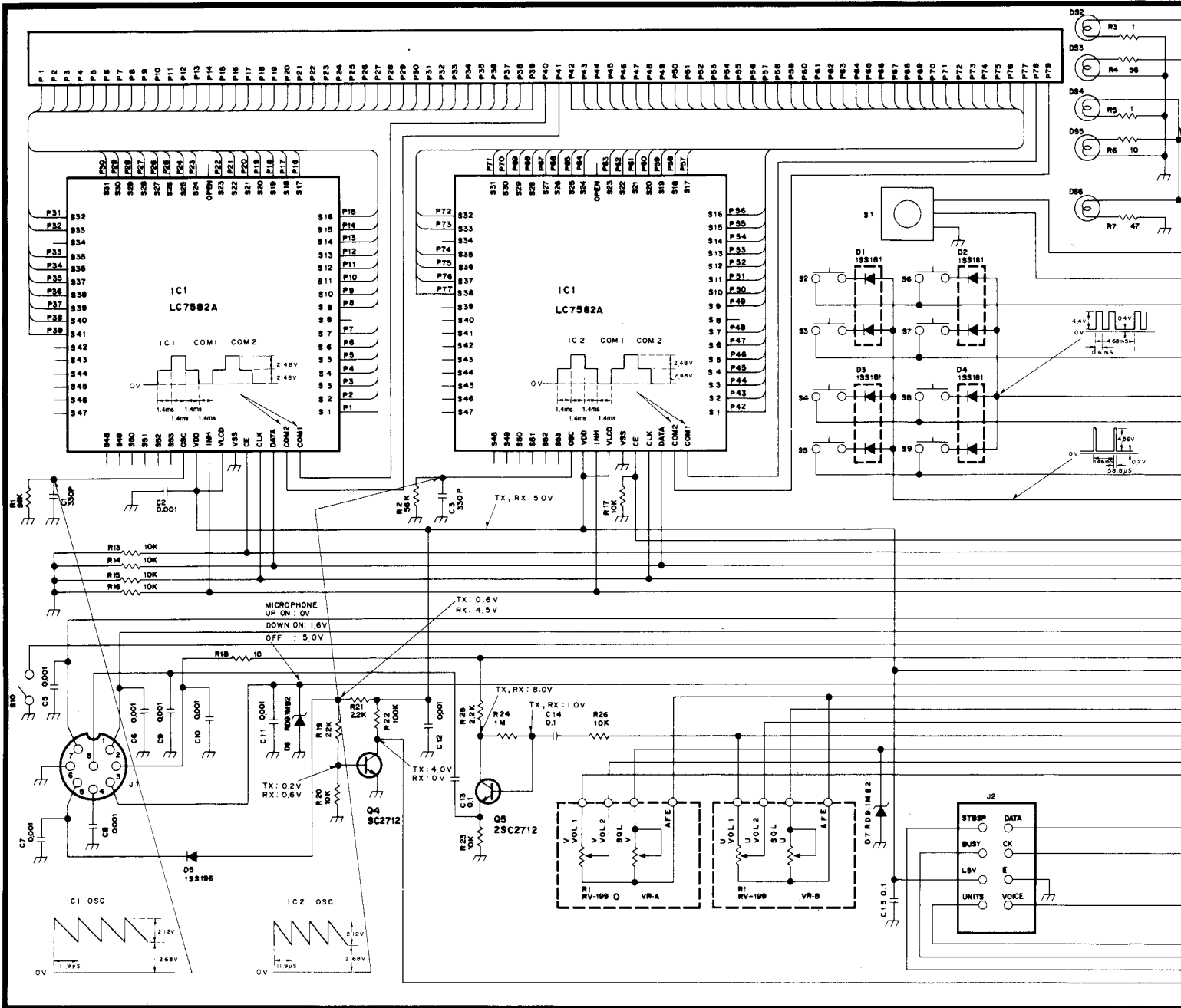

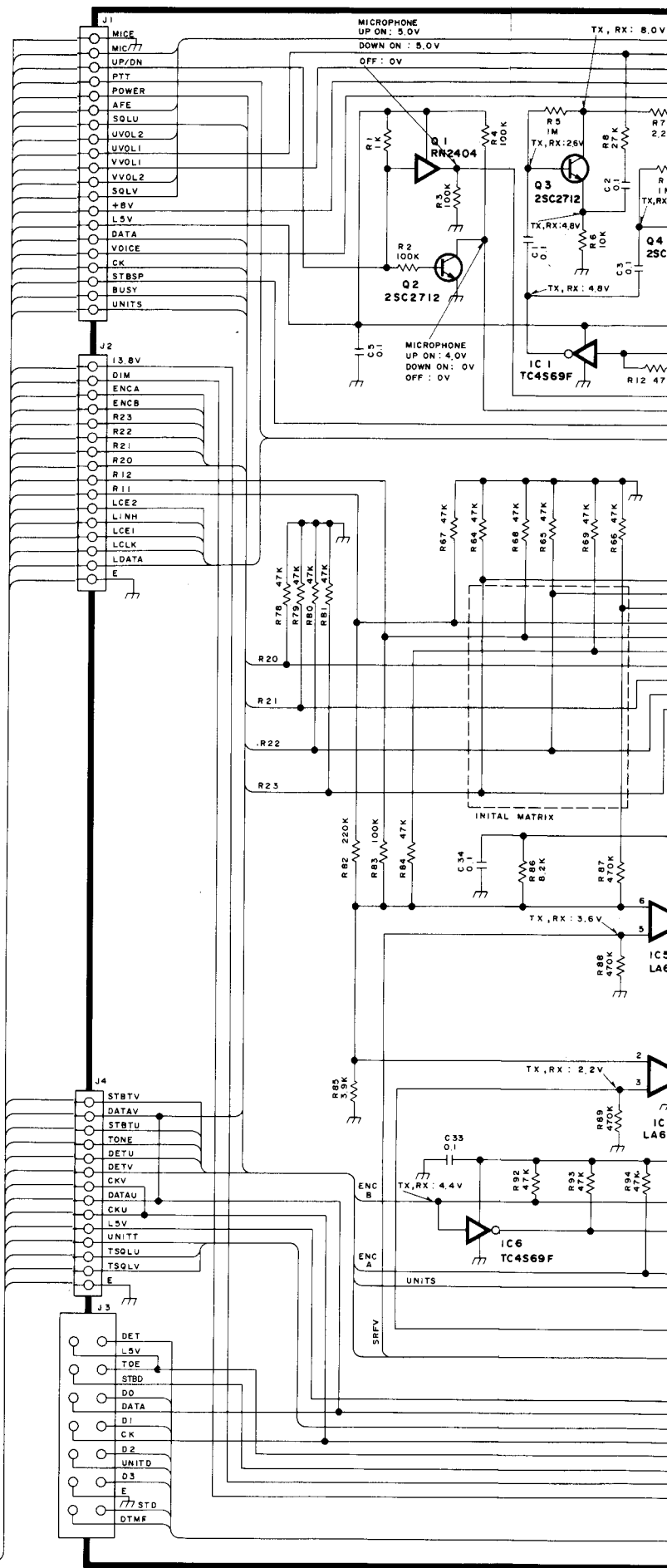
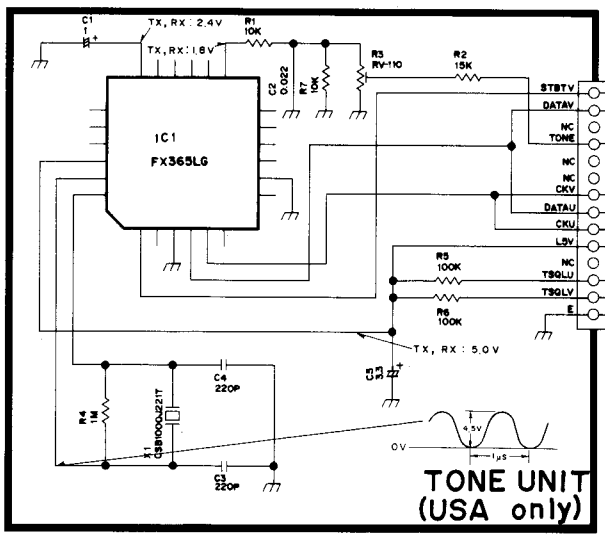
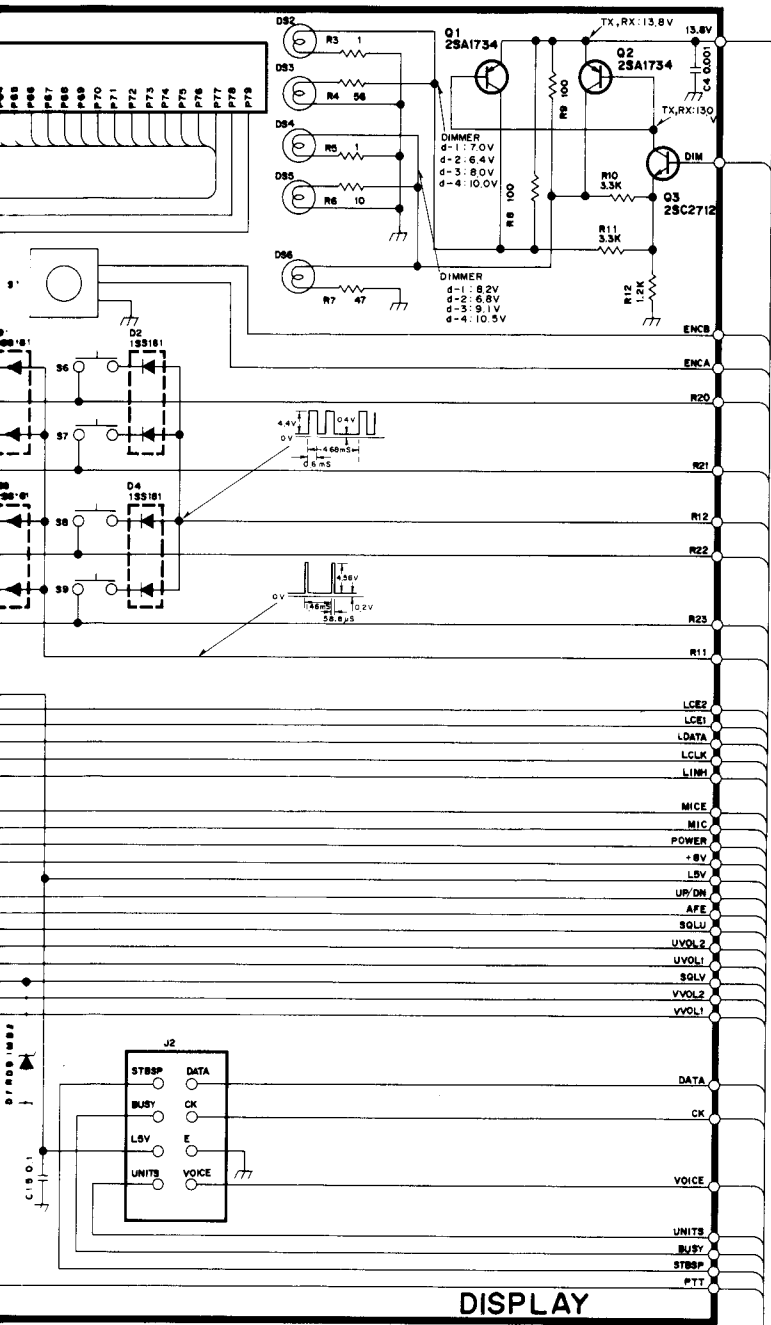

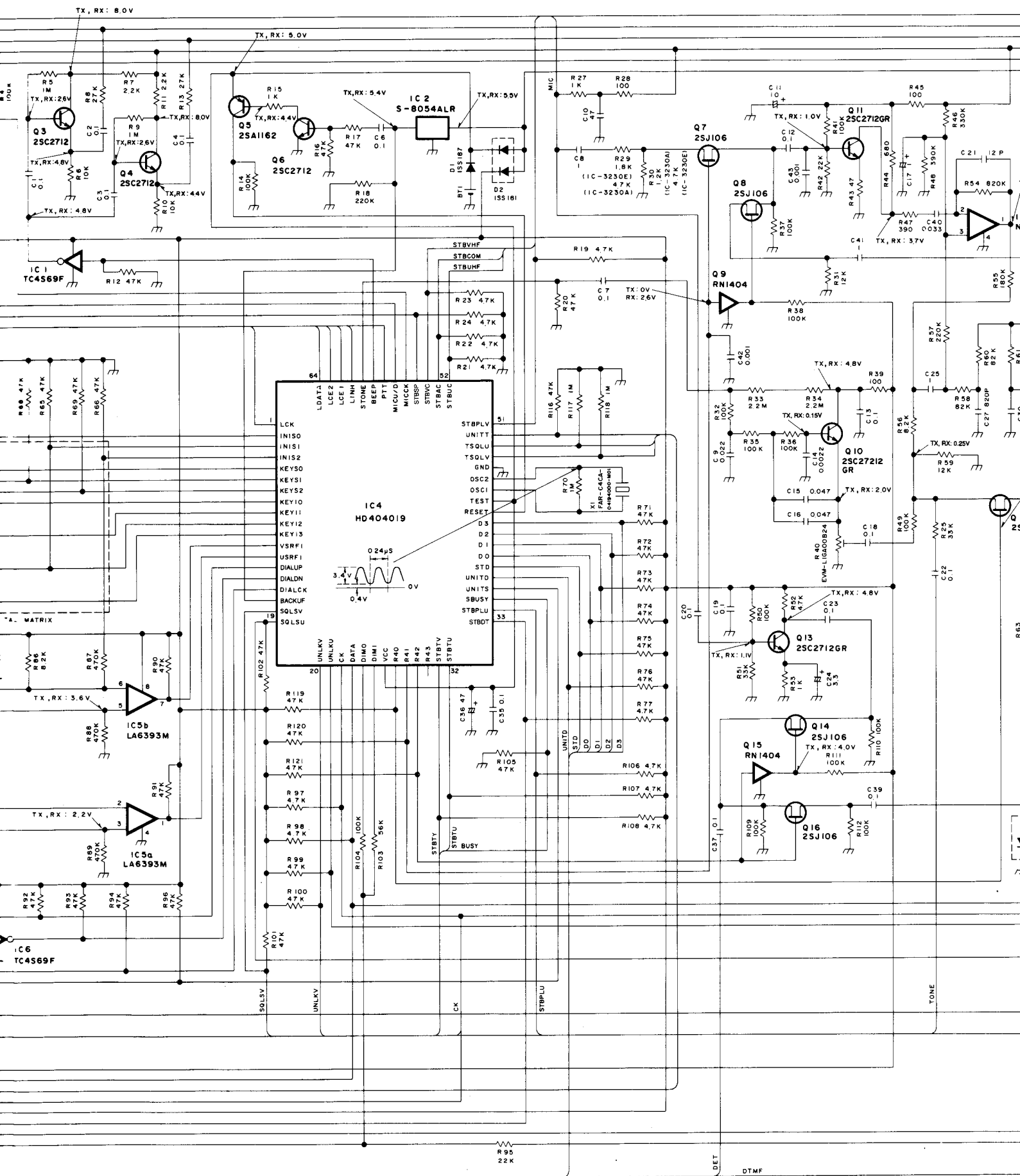

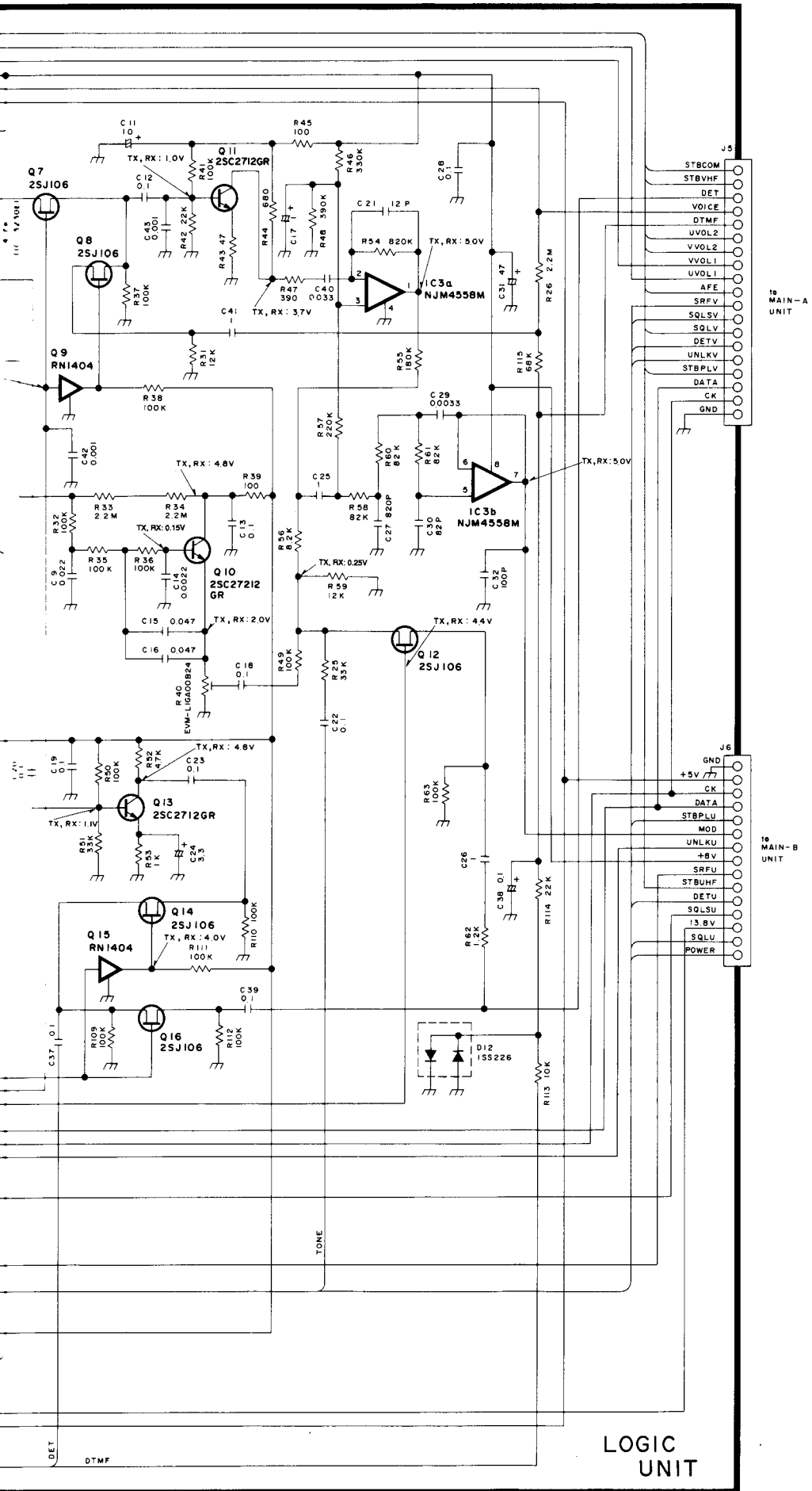

LOGIC UNIT

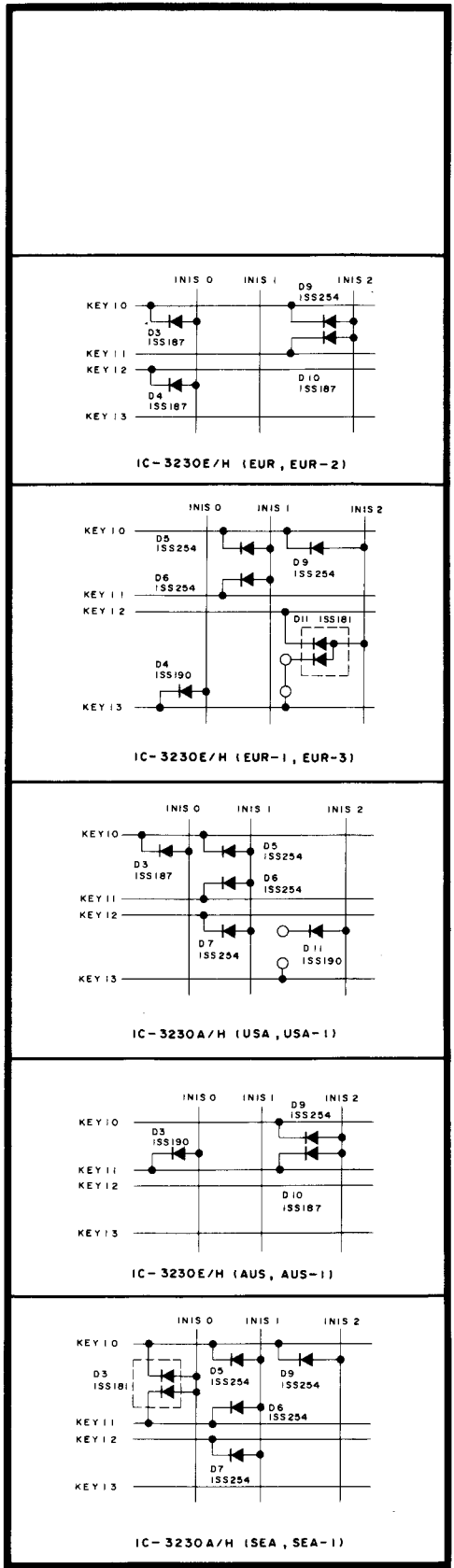

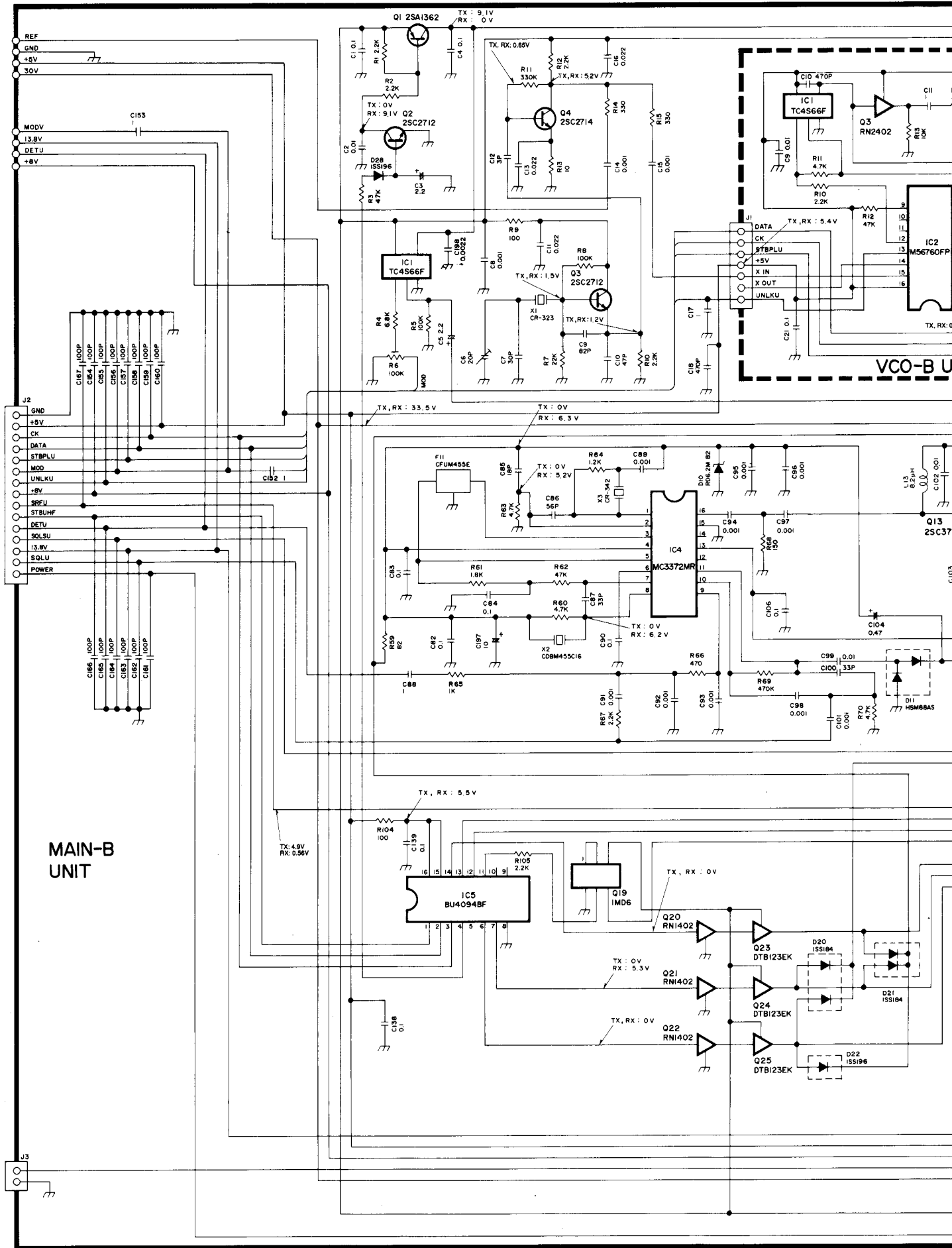

MAIN-B UNIT

VCO-B UNIT

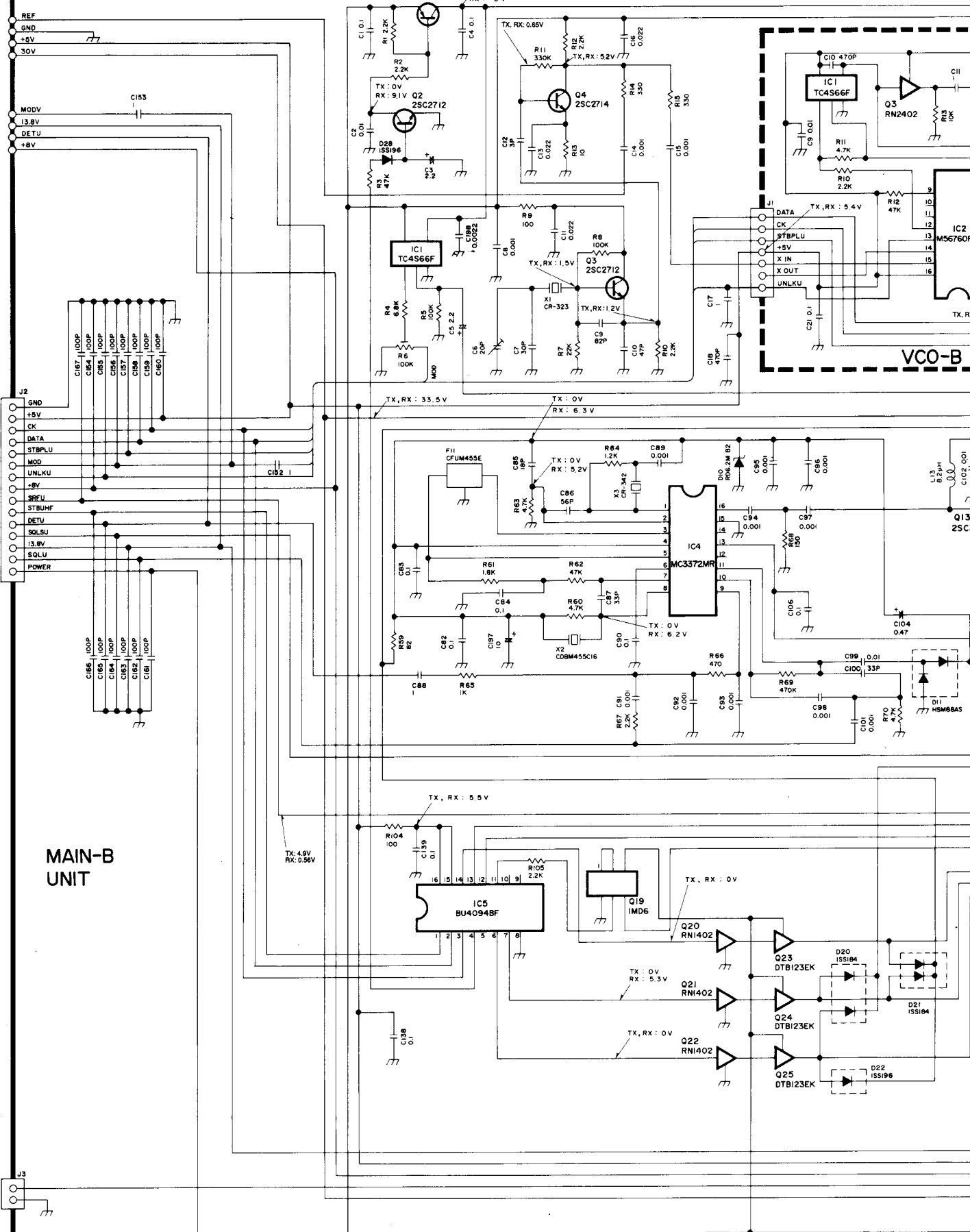

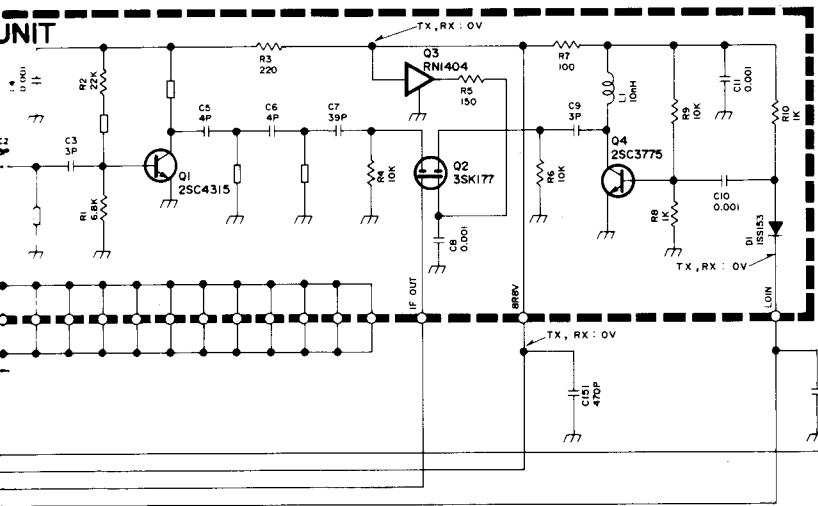
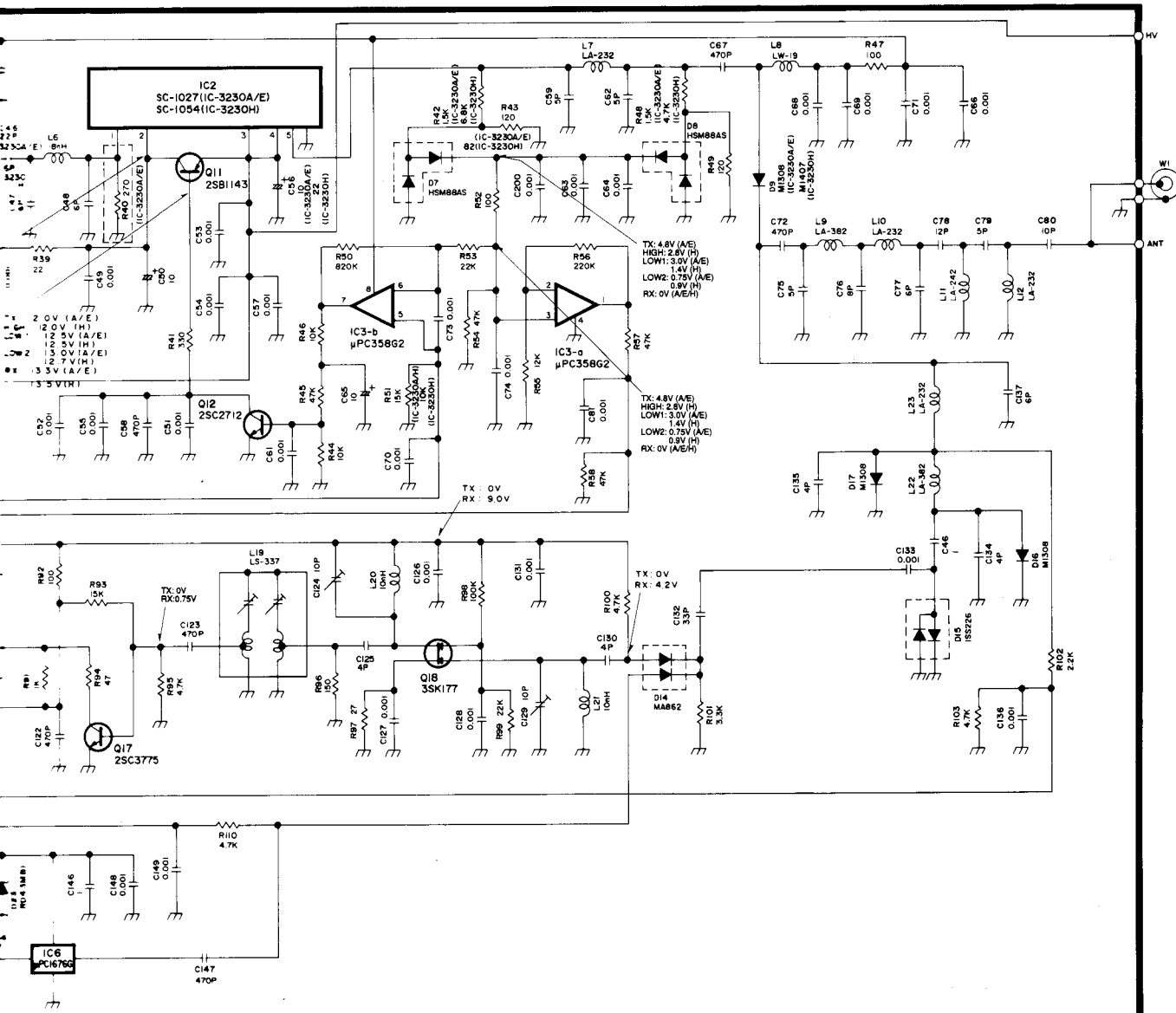

Icom Inc.

6-9-16, Kamihigashi, Hirano-ku, Osaka 547, Japan
Phone: 06 793 5301
Fax : 06 793 0013
Telex : 05277822 ICOMTR J

Icom America Inc.

<Corporate Headquarters>
2380 116th Avenue N.E., Bellevue, WA 98004 U.S.A.
Phone: (206) 454-8155
Fax : (206) 454-1509
Telex : 152210 ICOM AMER BVUE

<Customer Service>
Phone: (206) 454-7619

<Regional Customer Service Centers>
18102 Sky Park South, Suite 52-B, Irvine, CA 92714, U.S.A.
Phone: (714) 852-8026
Fax : (714) 852-8716

1777 Phoenix Parkway, Suite 201, Atlanta, GA 30349, U.S.A.
Phone: (404) 991-6166
Fax : (404) 991-6327

Icom Canada

A Division of Icom America Inc.
3071 #5 Road, Unit 9, Richmond, B.C., V6X 2T4, Canada
Phone: (604) 273-7400
Fax : (604) 273-1900

Icom (Europe) GmbH

Communication Equipment
Himmelgeister Str. 100, 4000 Düsseldorf 1, F.R.G.
Phone: 0211 346047
Fax : 0211 333639
Telex : 8588082 ICOM D

Icom (Australia) Pty. Ltd.

A.C.N 006 092 575
7 Duke Street, Windsor, Victoria, 3181, Australia
Phone: 03 529 7582
Fax : 03 529 8485
Telex : AA 35521 ICOM AS

Icom (UK) Ltd.

Unit 9, Sea St., Herne Bay, Kent, CT6 8LD, U.K.
Phone: 0227 741741
Fax : 0227 360155
Telex : 965179 ICOM G

Icom France S.a

Zac de la Plaine, Rue Brindejonc des Moulinais
BP 5804, 31505 Toulouse Cedex, France
Phone : 61. 20. 31. 49 Fax : 61. 34. 05. 91
Telex : 521515 ICOM FRA

Count on us!

